

Manual of Forklift Truck



INDEX

FOREWORD	1
SAFETY RULES FOR FORKLIFT TRUCK OPERATIONS	2
KNOW YOUR FORKLIFT TRUCK	19
HOW TO AVOID A TIPOVER; HOW TO SURVIVE ONE	28
OPERATION	31
DAILY PRE-OPERATION INSPECTION	32
OPERATION	33
POST-OPERATION INSPECTION AND STORAGE	43
OPERATING TECHNIQUES	45
SPECIAL SITUATIONS	47
TROUBLESHOOTING	49
MAINTENANCE	59
SERVICE DATA	72
NOTICE OF SIDESHIFT'S INSTALLATION, EMPLOYMENT AND SECURITY	74
MAINTENACE RECORD	84

FOREWORD

The purpose of this of manual is to give you a complete understand of Truck and enable you to operate it correctly and safely Additionally; it can help you to avoid, and provide you with the solutions to the troubles that may occur during operation. This manual is the same whit: FD20-HG / FD(GL)20T-HG / FD(GL)20T-HW / FD25-HG / FD(GL)25T-HG / FD(GL)25T-HW / FD30-HG / FD(GL)30T-HG / FD(GL)30T-HW / FD35-HG / FD(GL)35T-HG / FD(GL)35T-HW.

We cordially suggest that you read this manual carefully; only by doing so, the minimum troubles, and the maximum safety and performance of the forkliftt ruck safety is the most important cause in the daily operation of a truck. Do not refit out forklift privately, otherwise, we are not responside for the results occurred. If the saferules given in this manual helps you to prevent from even one accident.The writing of this text has served a real purpose. (The caption in the manual as per the hecha forklift model which is used to exported. And changes, we will not issur a separate notice. If any question, please keep in touch with us.)

SAFETY RULES FOR FORKLIFT TRUCK OPERATORS

Warning Decals, Location

There are several specific warning decals on your forklift truck. Their exact location and description of the potential hazard are reviewed in this section. Please take the time to familiarize yourself with these decals.

Be sure you can read all warning and instruction decals.

You must replace a decal if it is damaged, missing or cannot be read. If a decal is on a part that is replaced, make sure a new decal is placed on the new part. Contact your Maximal Forklift Truck Dealer for new decals.

Inspect any moment to ensure the proper application of the sign in the process of using.

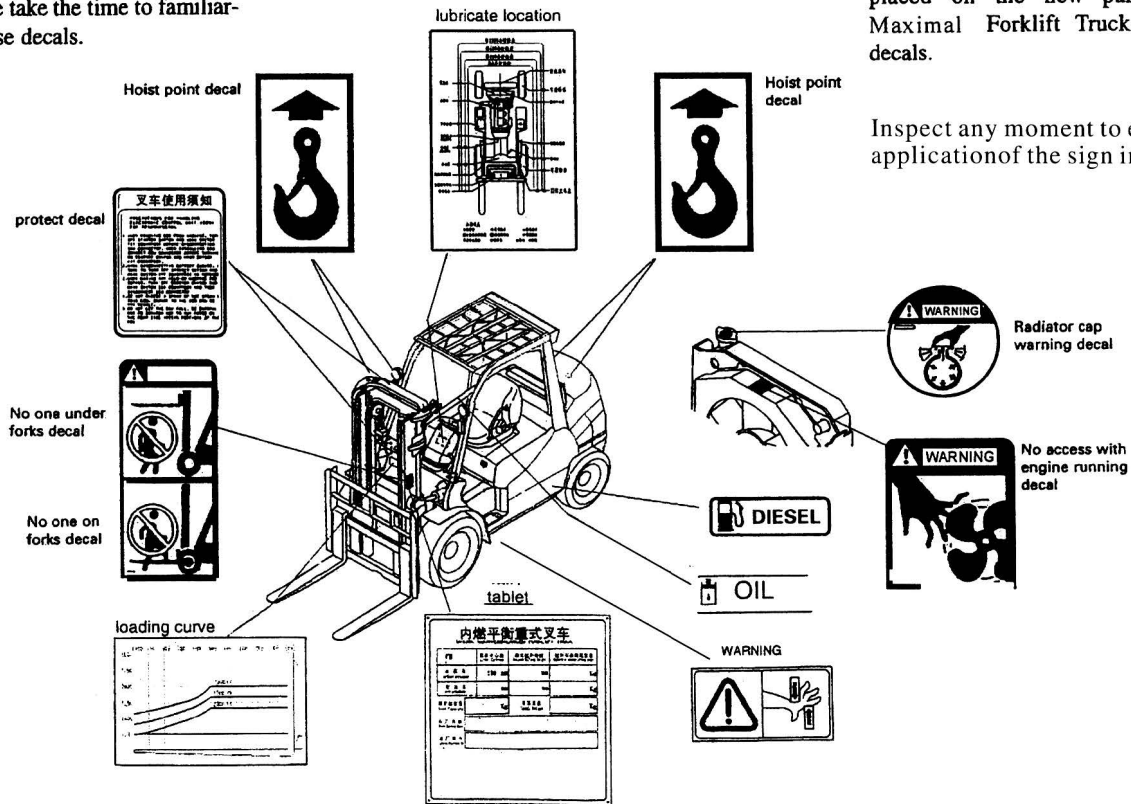

SAFETY RULES FOR FORKLIFT TRUCK OPERATORS

- **Cooling System**



Check the coolant level only after the engine has been stopped and the filler cap is cool enough to touch with your hands. Remove the filler cap slowly to relieve pressure.

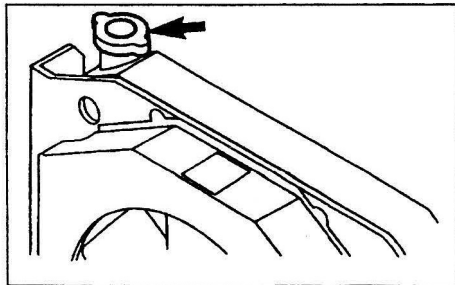

To avoid serious injury, stay clear of the moving fan.

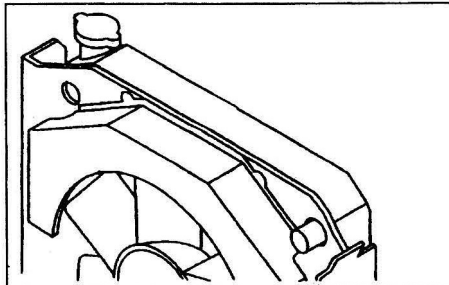

- **Overhead Guard**



Operation without this device in place may be hazardous.

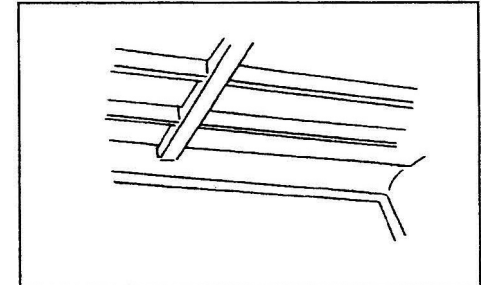

SAFETY RULES FOR FORKLIFT TRUCK OPERATORS

◆ Safety Rules



Authorized, trained operator only!

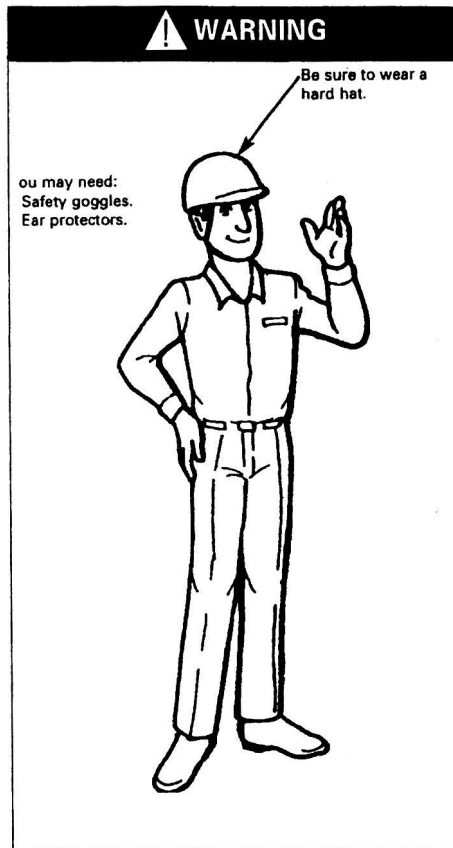

Dress properly for the job!



Be alert!

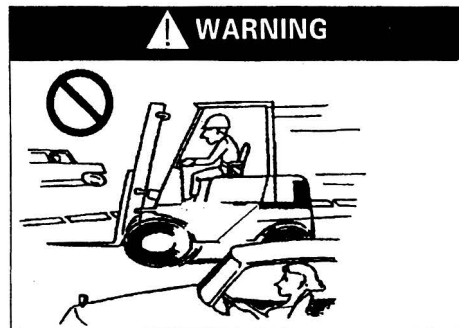

DO NOT travel on public roads!



Know your forklift truck and attachments!

SAFETY RULES FOR FORKLIFT TRUCK OPERATORS



Unauthorized addition or modification is prohibited!



Know your forklift truck and attachments!

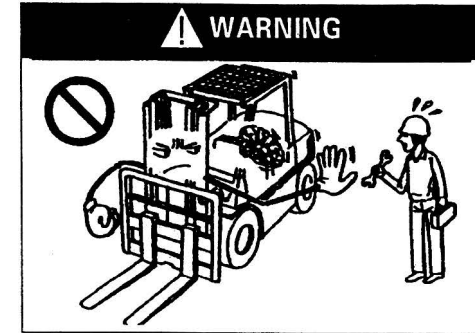

Shut down engine before servicing!



Know all signals and traffic rules!

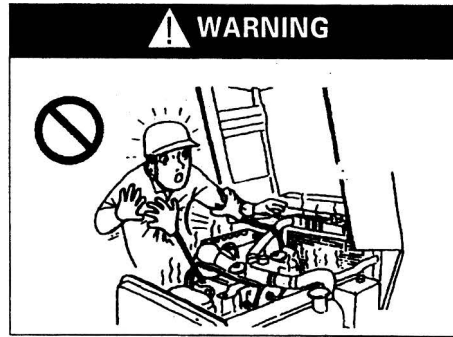

Avoid being splashed by scalding hot coolant!



Exhaust fumes can kill you!

SAFETY RULES FOR FORKLIFT TRUCK OPERATORS



Inspect your forklift truck prior to operation!

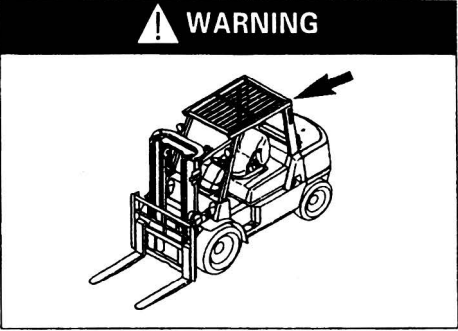

DO NOT remove the overhead guard!

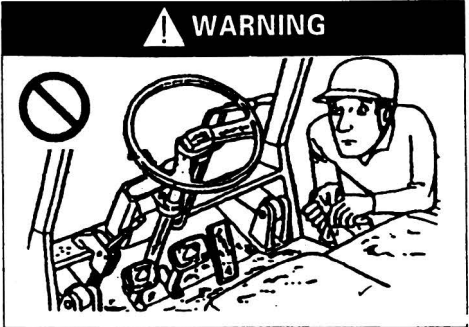

Keep the operator's compartment clean!



DO NOT operate an unsafe forklift truck!



Always stay healthy on the job!



Know your forklift truck is safe!

SAFETY RULES FOR FORKLIFT TRUCK OPERATORS

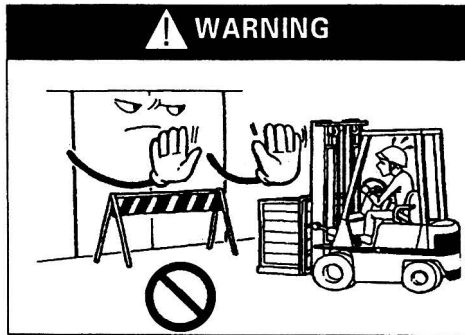

Operate only in approved areas!



DO NOT operate a damaged or defective forklift truck!



Be sure the assist grip is properly tightened



Start engine safely!



Position controls correctly for starting!



Operator should know where the fire extinguishers located

SAFETY RULES FOR FORKLIFT TRUCK OPERATORS



Adjust the seat before operation!



Make sure your forklift truck is in safe operating condition!



Fasten the seat belt properly!



Always check overhead clearance!

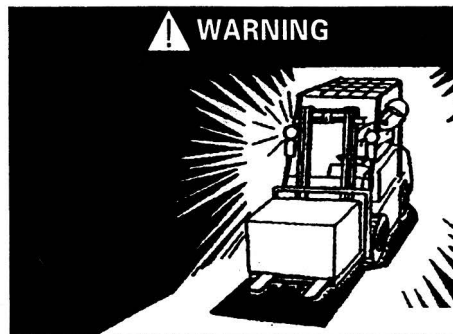

Use lights in dark, dim areas!



Stay within the confines of the truck!

SAFETY RULES FOR FORKLIFT TRUCK OPERATORS

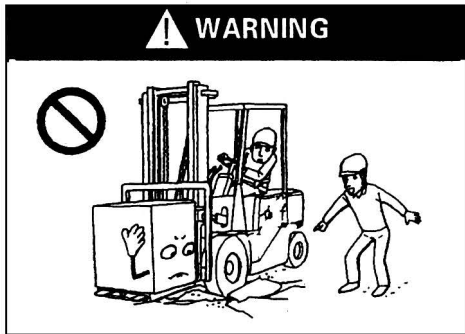

Avoid travelling on weak or nonprepared ground. Only running on a level and rigid place!



Stay under the overhead guard!

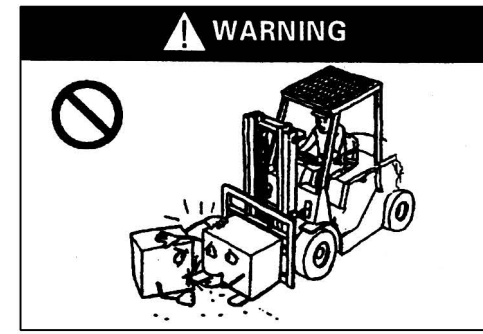

Be careful of forks that extend beyond the load!

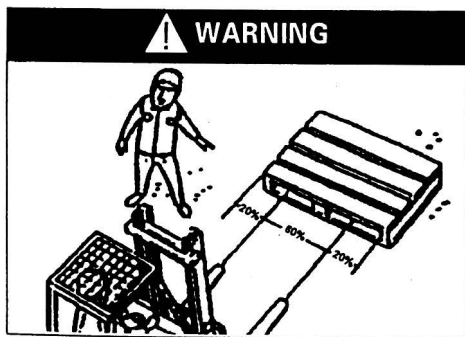

Avoid off-center loading!



Check fork stopper pin for engagement!

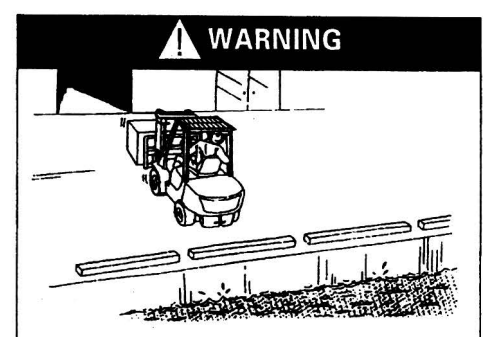

Check work areas for high risk!

SAFETY RULES FOR FORKLIFT TRUCK OPERATORS

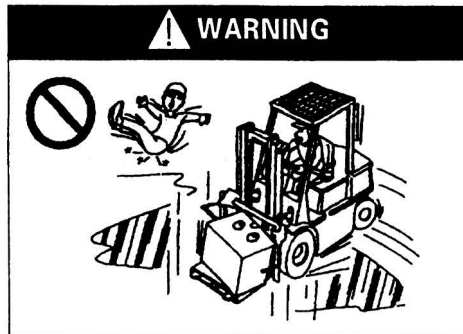

Stay away from slippery surfaces!

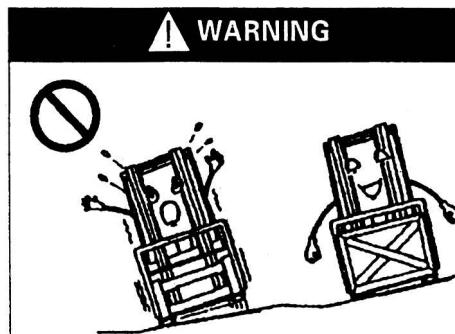

Be aware of the stability of an empty forklift truck!

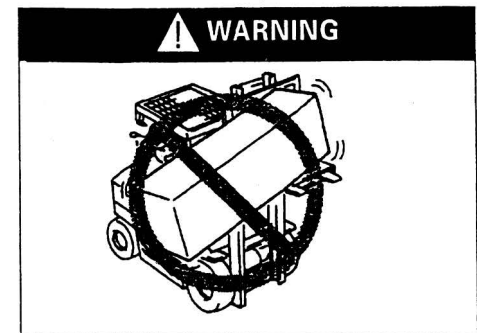

Take special care when carrying a long or wide load.



DO NOT allow any riders!



If you cannot see where you are going, DO NOT MOVE!



Use pallets and skids suitable for the little load.

SAFETY RULES FOR FORKLIFT TRUCK OPERATORS

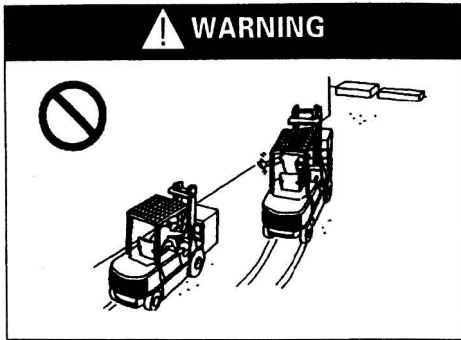

DO NOT pass another truck!



DO NOT allow anyone to hold loads!



Always look in the direction of travel!



DO NOT engage in stunt driving or horse-play!



Travel in reverse if forward visibility is blocked!

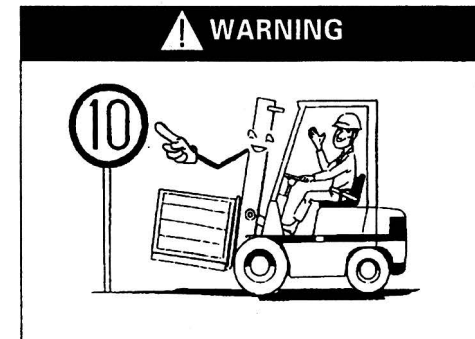

Obey all traffic rules and warning signs!

SAFETY RULES FOR FORKLIFT TRUCK OPERATORS

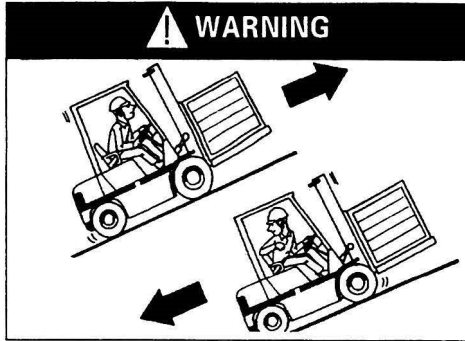

Travel safely on grades with a loaded forklift truck!

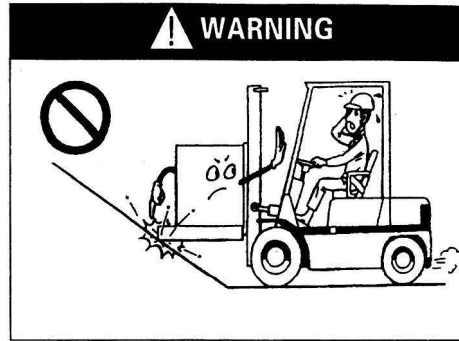

Be particularly careful when driving up or down a steep slope!

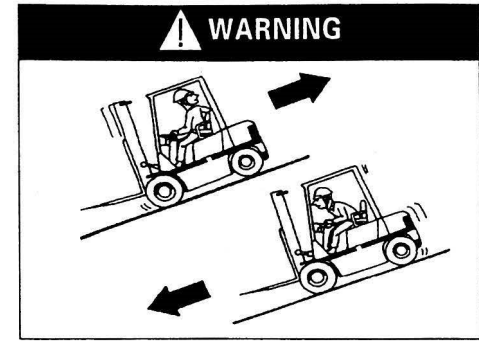

Travel safely on grades with an empty forklift truck!

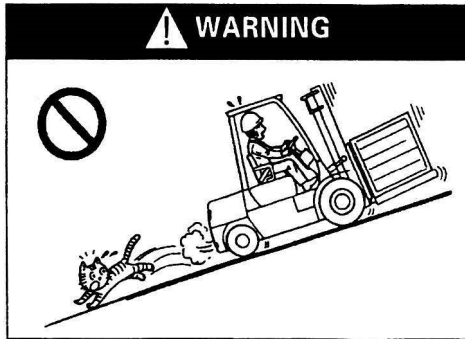

Start forklift truck upgrade carefully!



DO NOT turn on a ramp or grade!

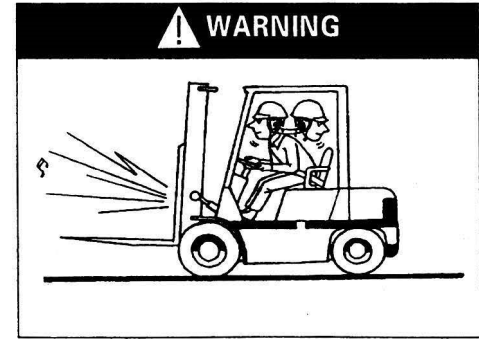

Move your forklift truck safely!

SAFETY RULES FOR FORKLIFT TRUCK OPERATORS

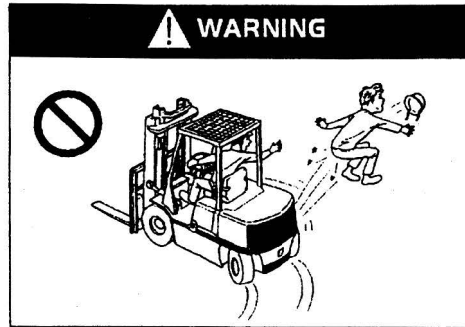

Allow for counterweight swing distance!

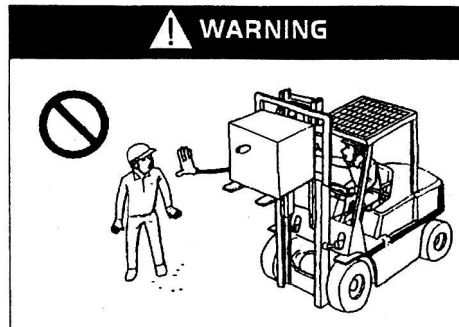

A helper should NOT be near the forklift truck!

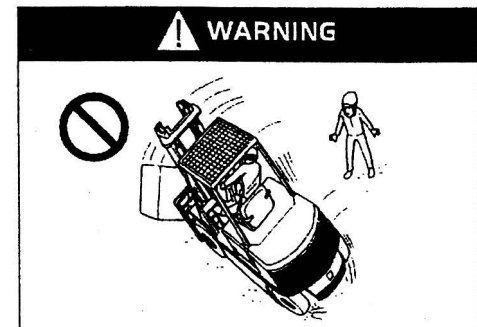

Always be alert for tipovers!



Danger! Keep out!



Be careful of changes in rated capacity!



Watch out for pedestrians at all times!

SAFETY RULES FOR FORKLIFT TRUCK OPERATORS

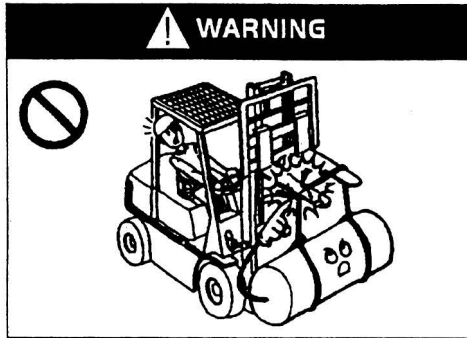

Use forks properly!

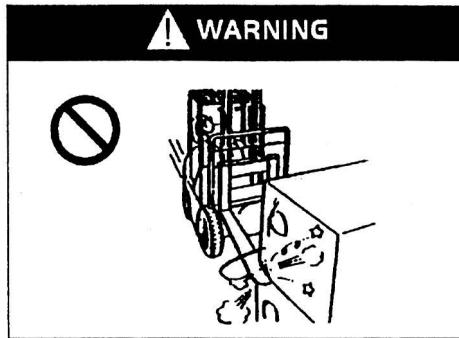

DO NOT speed when approaching loads!



DO NOT move when someone's next to truck!



DO NOT allow anyone to walk or stand under raised forks!



DO NOT pick up unsecured loads that extend above the backrest extension height!

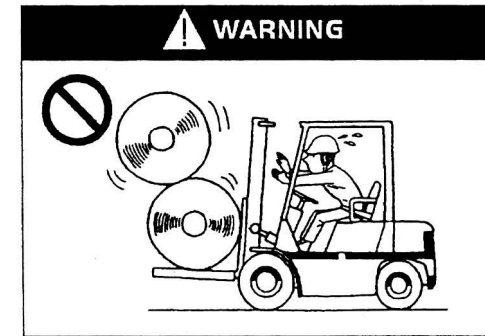

Handle only stable loads!

SAFETY RULES FOR FORKLIFT TRUCK OPERATORS

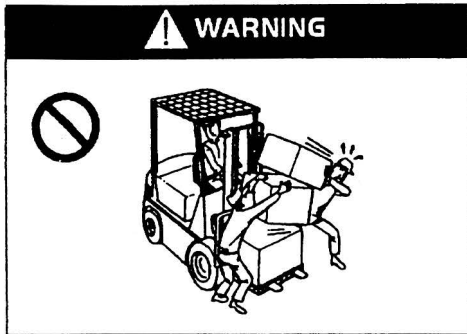

DO NOT allow unloading from raised loads!



DO NOT use damaged pallets!

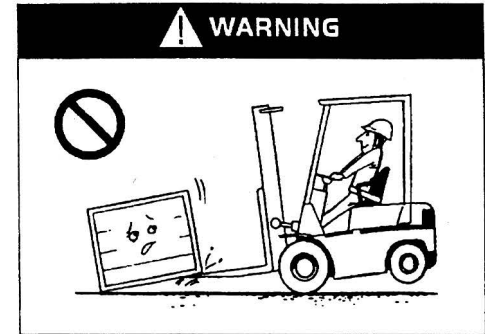

DO NOT abuse your forks!

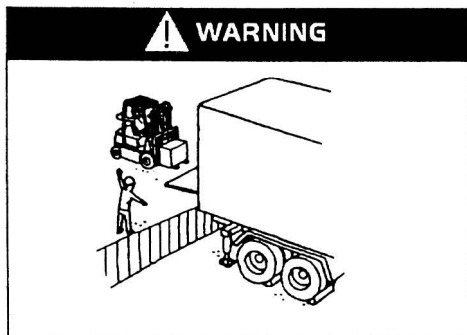

Drive onto a trailer carefully!



DO NOT allow any riders!

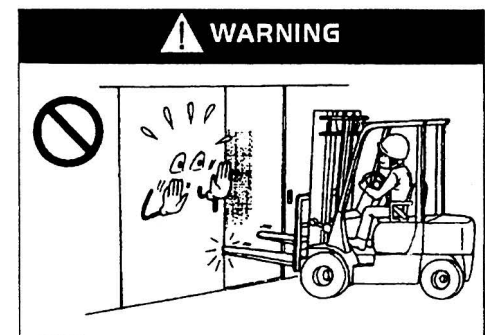

DO NOT abuse your equipment!

SAFETY RULES FOR FORKLIFT TRUCK OPERATORS



Stay clear of pinch points!



Shift the transmission smoothly!



Use only specialized equipment designed to safely raise personnel to high work areas!



Always stay within the rated capacity!



DO NOT elevate in blustery weather.

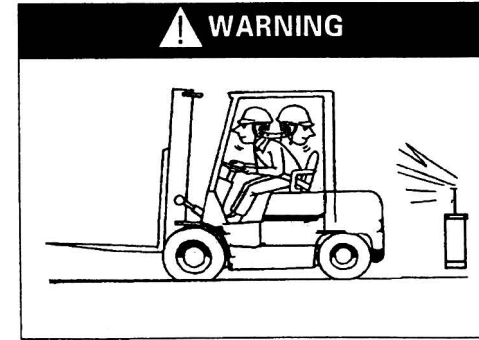

Forbid to operate in the circumstance here is easy to explode.

SAFETY RULES FOR FORKLIFT TRUCK OPERATORS

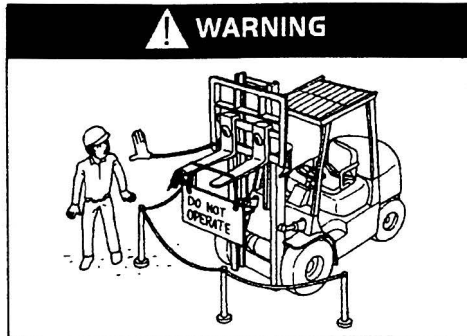

Park a disabled machine safely!

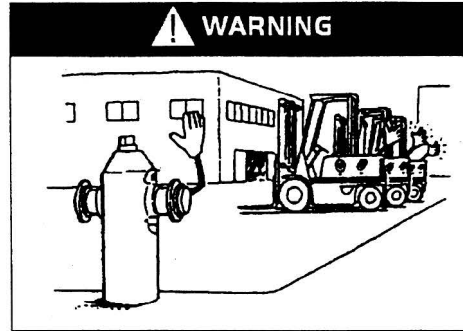

Park in authorized areas only!

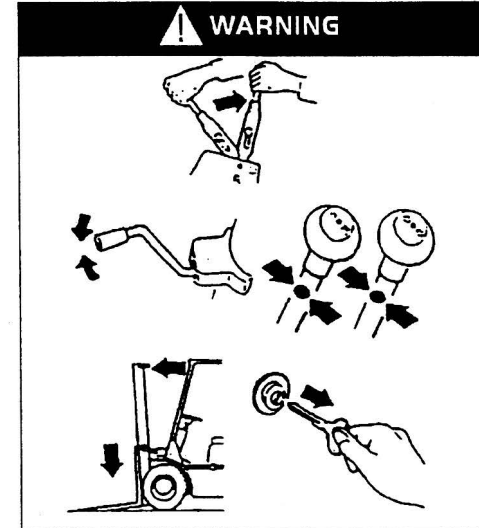

When you leave your truck, or park it:

- Set the parking brake.
- Put the direction and gearshift lever in NEUTRAL.
- Lower the forks fully to the floor.
- Tilt the mast forward until the forks are flat.
- Turn the key off.



DO NOT park on a grade!

SAFETY RULES FOR FORKLIFT TRUCK OPERATORS

■ Transportation



Hoisting with overhead guard prohibite!

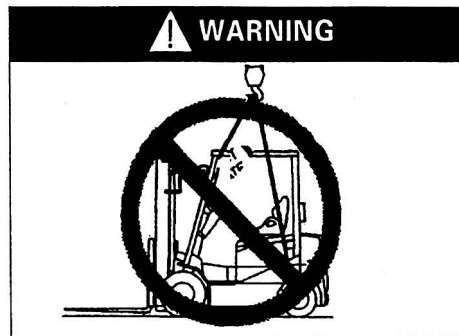

Hoisting with frame prohibited!

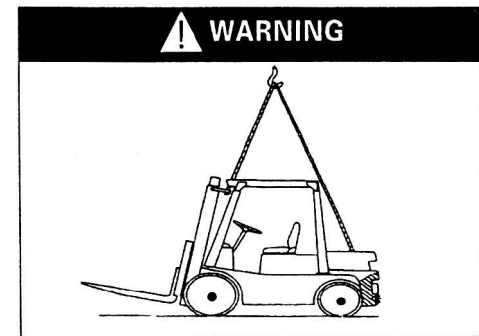

Hoisting with the right way!

⚠ CAUTION

1. Please use the right way to hang up when ship the forklift.
2. See that there is no fuel left in the fuel tank.
3. Please fix the wheel by log when transport and the hand brake.
4. Please fix the body basic with belt.

KNOW YOUR FORKLIFT TRUCK

◆ Model View

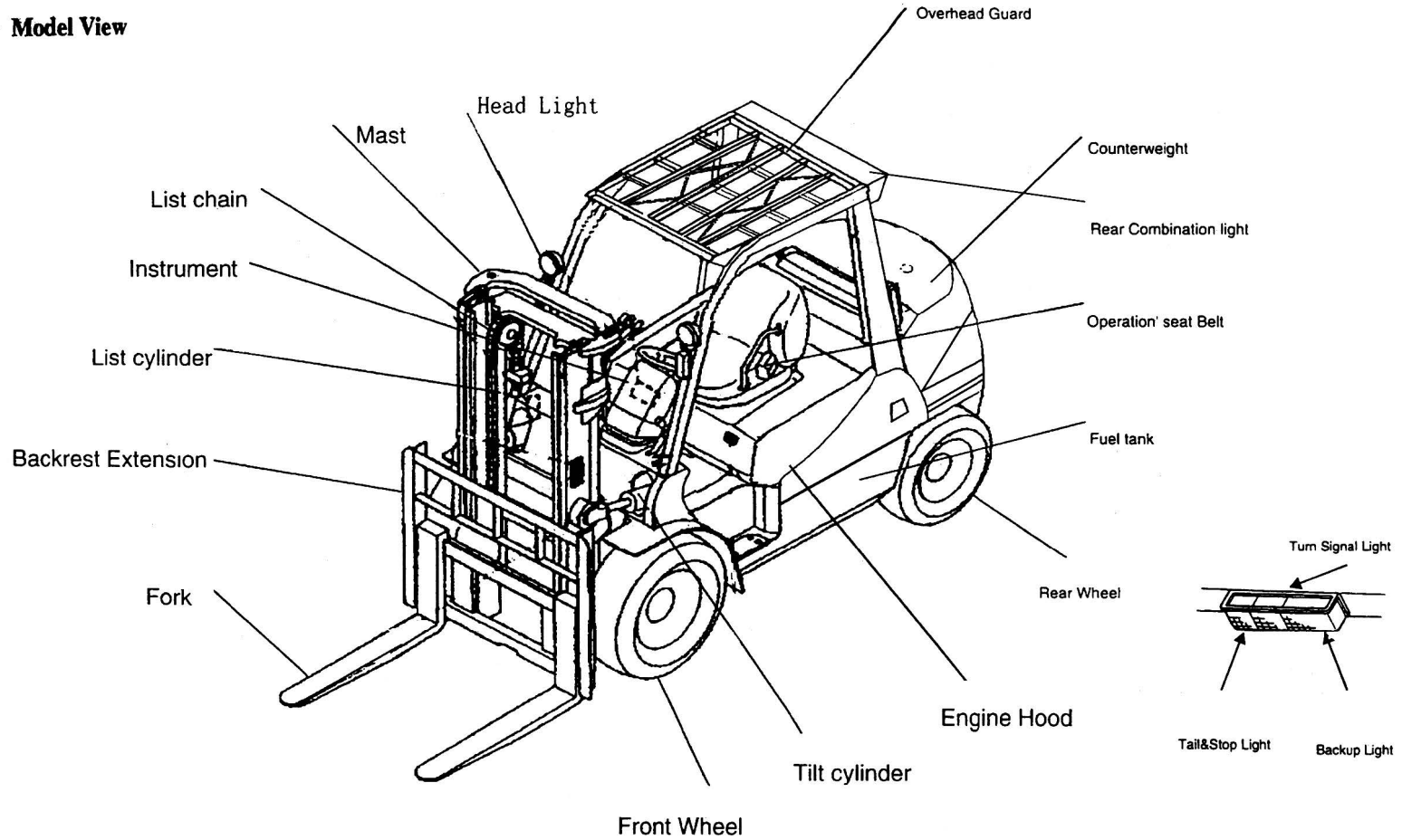

Rear Combination Light

KNOW YOUR FORKLIFT TRUCK

◆ Operator's Compartment

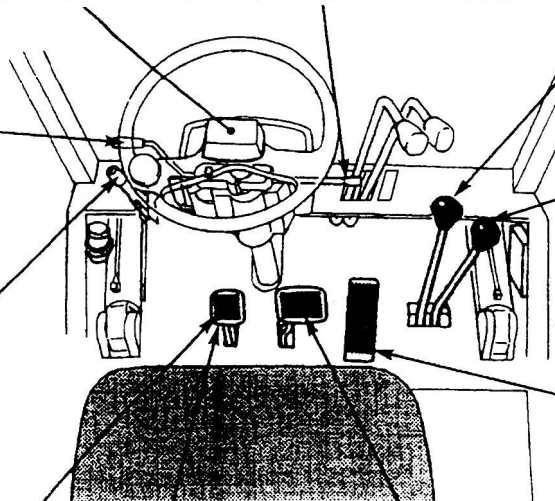
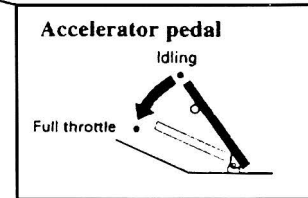
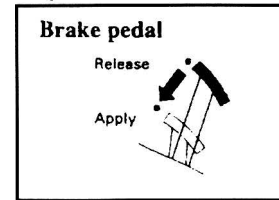
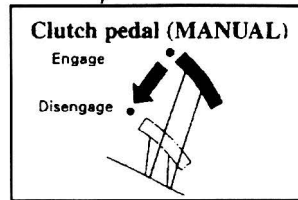
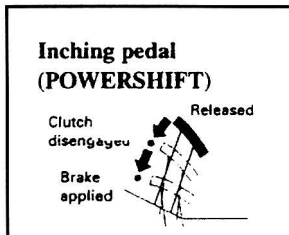
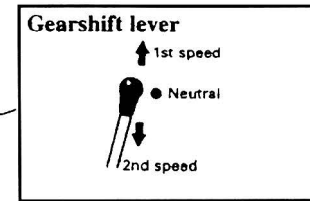
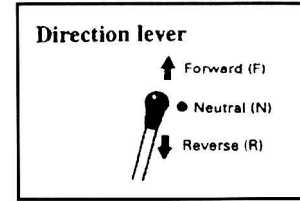
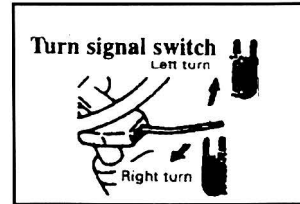
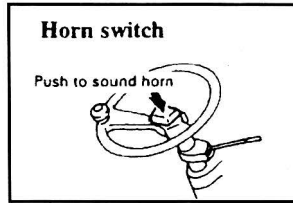
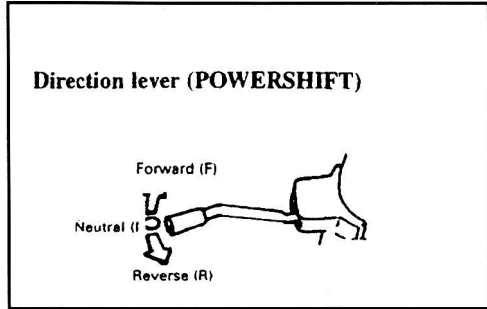

KNOW YOUR FORKLIFT TRUCK

• **Steering Tilt Lever**

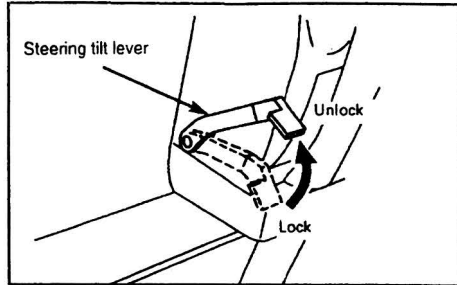

Move the lever in arrow direction to unlock the steering wheel.

Push down the lever to lock the steering wheel.

• **Lift Control Lever**

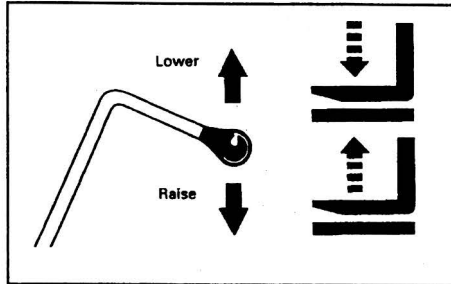

Lifting speed is controlled by the speed of the engine (the position of the accelerator pedal) and the position of the control lever.

• **Tilt Control Lever**

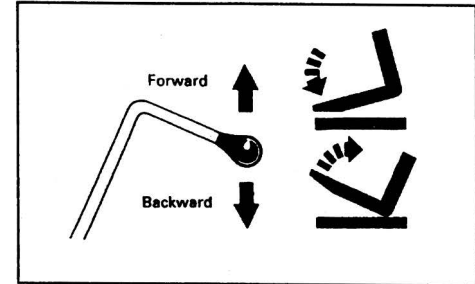

Tilting speed is controlled by the speed of the engine (the position of the accelerator pedal) and the position of the control lever.

The lever will return to the NEUTRAL position when released.

The lever will return to the NEUTRAL position when released.

⚠ WARNING

- Always adjust the steering wheel tilt angle while stopped at a safe place, as adjustment while driving may lead to accidents.

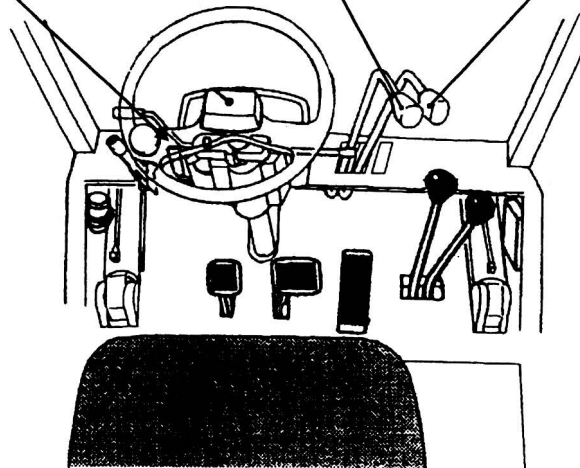

KNOW YOUR FORKLIFT TRUCK

◆ Instrument Panel

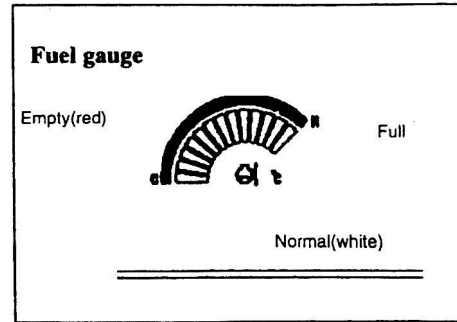
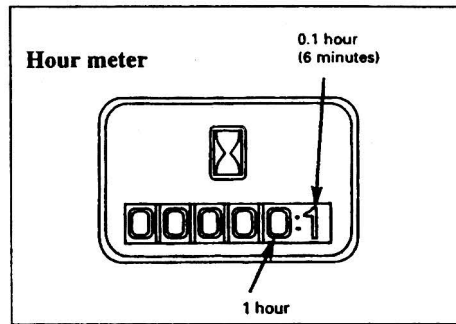

Powershift transmission oil temperature gauge (optional)

Starts registering the operating hours of the engine when the key is turned to the I (ON) position.

Indicates the amount of fuel in the tank when the key is turned to the I (ON) position. To get an accurate gauge reading, be sure the truck is level.

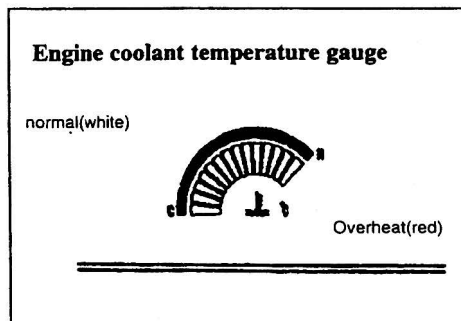

The gauge needle is normally in the white zone. If the needle moves into the red zone, set the topic.

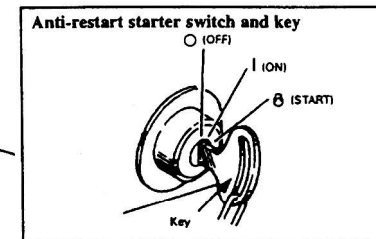
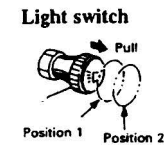
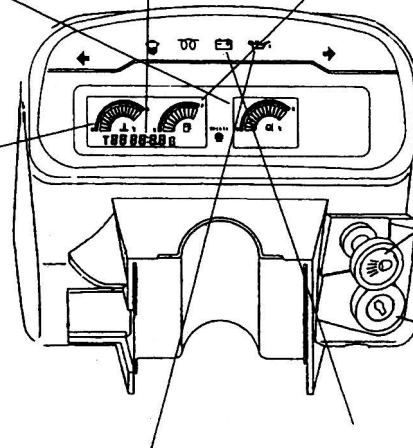

Engine oil pressure warning light

Alternator not charging warning light

KNOW YOUR FORKLIFT TRUCK

Adjustment of Operator's Seat



Adjust the seat before starting the engine. After adjusting, jiggle the seat to make sure it is properly locked.

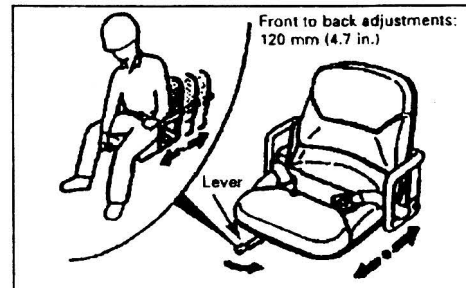

Move the lever to the left, slide the seat to one of the seven positions.

Item	Truck model	FD20, FD20T	FD25, FD25T	FD30, FD30T	FD35, FD35T
arm touched shaking quantity per day.		A(8) < 5m/s ²			
trunk body touched shaking quantity per day.		A(8) < 5m/s ²			
the level of noise power.		≤ 104dB			
1. The way to test the noise is up the Euro-criterion 12053:2001. 2. The noise figure will be raised up when the tire has been over damaged and the ground condition is bad,					

KNOW YOUR FORKLIFT TRUCK

Seat Belt



1. Wear your seat belt anytime you operate a forklift truck.

The seat belt will help to restrain you in accidents such as a tipover or front end collision. If you are unrestrained in a tipover, you can fall outside of the operator's compartment and be crushed by the forklift truck.

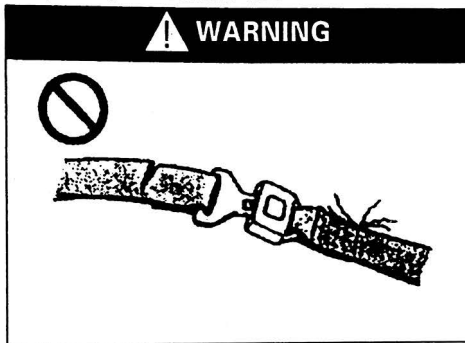

2. Please replace it wherever the seat belt is torn.



3. Also, replace the seat belt assembly if it was worn during an accident.



Seat belts can "jack-knife" drivers—the upper body bends tightly at the waist. If you are pregnant or have suffered an abdominal disease or injury, consult a doctor before using the seat belt.

Control valve

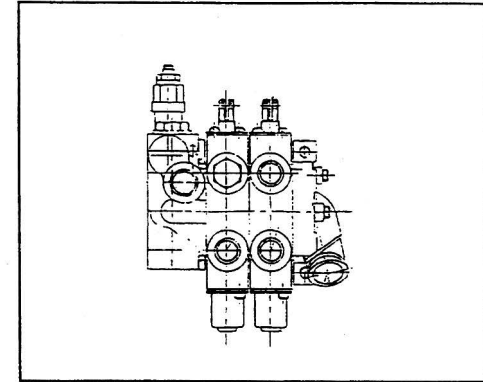

The safe valve in the multi-valve is used to control the maximum capacity that is allowed or the quickly increasing pressure figure of the hydraulic system when the cylinder piston comes to the position limited. When the capacity pressure is up to 10% of the rated capacity the forklift can realize the operation of rise up, while 25% can not. And it has been adjusted as it was produced, and it can not be adjusted privately and freely. If any question, please keep in touch with us FEELER or directly with our sales service department.

KNOW YOUR FORKLIFT TRUCK

◆ Fork Stoppers



When adjusting the fork spread, be careful not to pinch your hand between forks and lift bracket.

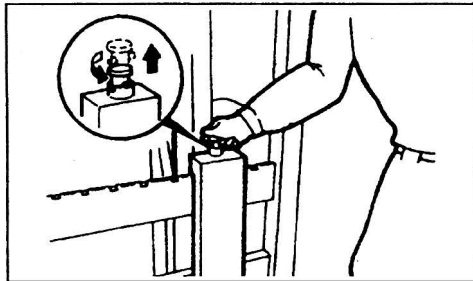

For load stability, adjust the forks as wide as possible.

◆ Changing Forks

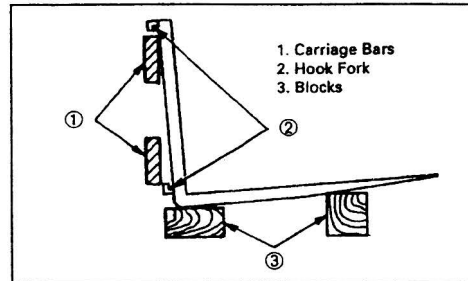

• To Remove

Remove a fork from the carriage to replace it or to access other parts of the truck for maintenance. Slide the forks, one at a time, to the installation/removal notch on the bottom carriage bar. Tilt the carriage forward, then lower it until the hook fork disengages the forks from the carriage. Use a lifting device to move the forks away from the truck.

• To Install

Position the forks side-by-side on the floor in a location where they can be approached from the rear by the forklift truck. Slowly drive the forklift truck, with the carriage fully lowered and fully tilted forward, to a point just to the rear of the forks. Carefully slide the forks, one at a time, onto the carriage so the top hook of the fork is placed above the top carriage bar. Raise the carriage to engage the top hooks allowing the bottom hooks to pass through the installation/removal notch. Then carefully slide each fork on the carriage so both the upper and lower hooks engage the carriage. Lock the forks in place by engaging the fork lock pins.

⚠ CAUTION

1. Adjust the fork position according to the size of load to be handled.
2. The forks can be moved to a desired position by pulling out the upper anchor pin.
3. Do not hold the fork when moving the fork. This may cause your fingers to be caught. Push and slide the fork from behind.
4. After moving the fork, securely insert the anchor pin in the fork carriage.

KNOW YOUR FORKLIFT TRUCK

◆ Drawbar Pin



DO NOT use the drawbar pin for towing loads.

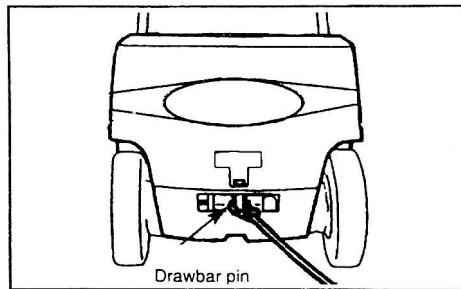

Use the drawbar pin for:

- Pulling the truck out of a drop-off or ditch.
- Loading the truck on a hauling truck.



Precautions for Use of the Drawbar Pin

1. When hitching a cable to the pin, make sure the pin is inserted safely.
2. Take up slack slowly—DO NOT jerk. Keep the cable taut. If the cable is slack, the sudden impact of the load can snap it, resulting in an accident.
3. A helper should stand at a safe distance and watch the pin. Stop pulling with the truck, relieve tension, and reduce load if the pin starts to come out.

◆ Assist Grip



**DO NOT grab the steering wheel or lever.
DO NOT jump on or off the truck.**

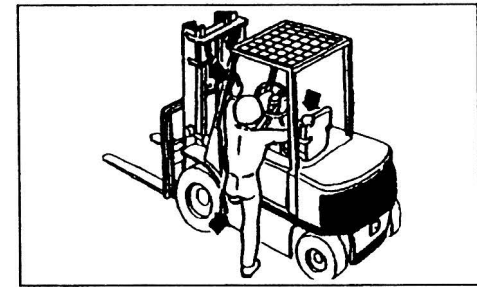

- Grasp the assist grip with the left hand, the seat backrest with the right hand, and step up with the left foot to get on the truck safely.
- Grasp the assist grip with the right hand, the seat backrest with the right hand, and step up with the left foot to get down the truck safely.

KNOW YOUR FORKLIFT TRUCK

◆ Hydraulic Tank Oil Level/Filler Hole

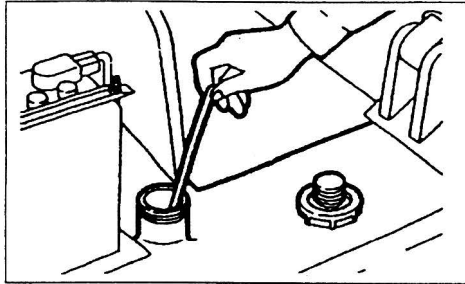

The oil level/filler hole is located on the right side of the truck inside the engine hood.

◆ Fuel Filler

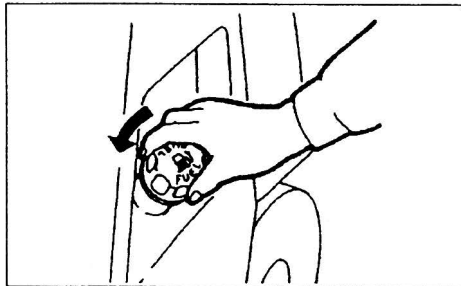

The fuel filler is located on the left side of the truck. The cap can be removed by turning it counterclockwise.

◆ Fuel Shut-off Valve

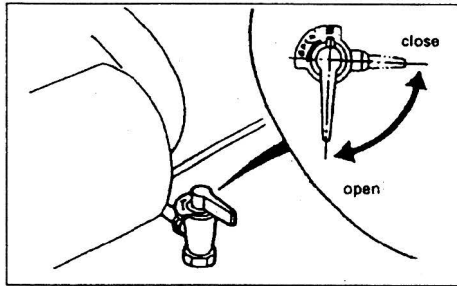

The fuel shut-off valve is located near the air cleaner inside the engine hood. In an emergency or when performing maintenance, close this valve.

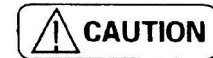

Confirm the engine type before filling the tank with the recommended fuel.



Never fill the tank near an open flame or when the engine is running.



After refueling, close the cap tightly and wipe up spillage.

HOW TO AVOID A TIPOVER; HOW TO SURVIVE ONE



DO NOT tilt elevated loads forward!



DO NOT elevate tilted loads!



DO NOT pick up an off-center load!

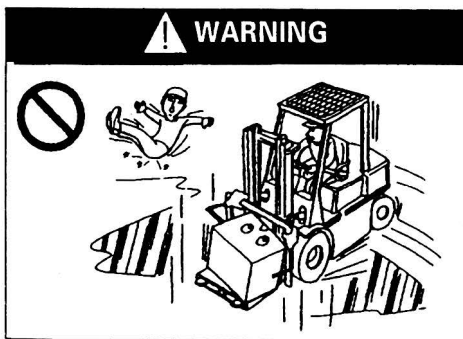

DO avoid slippery surfaces!

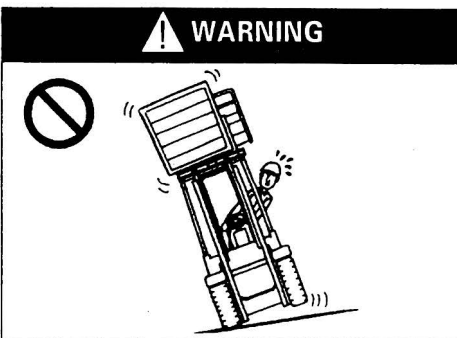

DO NOT attempt to pick up or deposit a load unless the forklift truck is level!

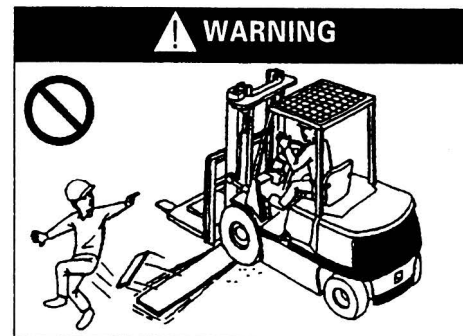

DO NOT go over obstacles—curbs, ditches, ridges and railroad tracks!

HOW TO AVOID A TIPOVER; HOW TO SURVIVE ONE

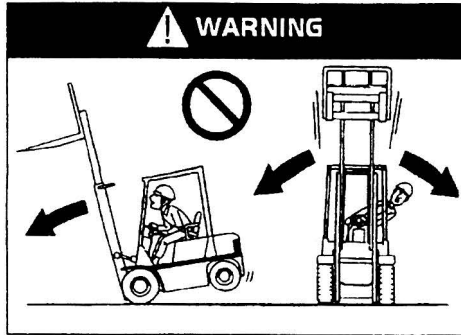

DO NOT travel with forks higher than 15 to 20cm (6 to 8 in.) above the ground!

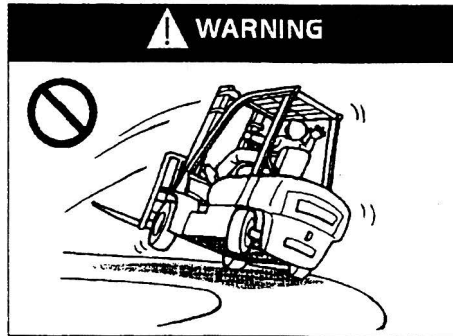

DO NOT make fast or sharp turns with a loaded or unloaded truck!



DO NOT turn too sharply, even with an empty raised mast, to avoid a tipover!

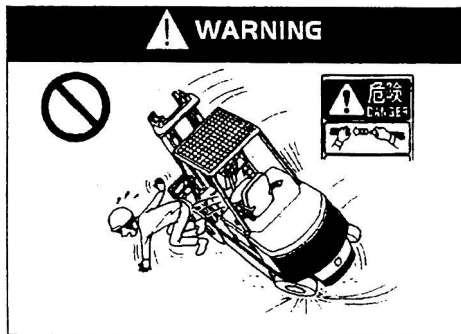

DO fasten your seat belt!

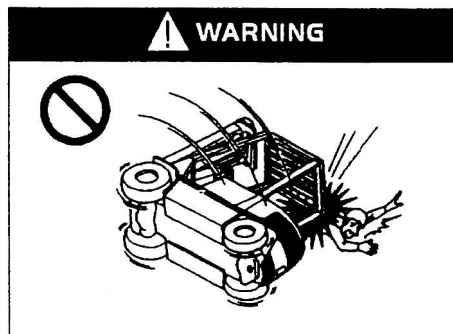

DO NOT jump off your truck if it starts to tipover!



DO wear a hard hat!

HOW TO AVOID A TIPOVER; HOW TO SURVIVE ONE

◆ How to Survive in a Tipover

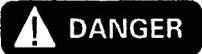

Remember, your chances for survival with your seat belt fastened in a tipover are better if you stay in your truck. If your truck starts to tipover:

- 1. Firmly hold on to the steering wheel and brace your feet.**
- 2. DO NOT jump off!**
- 3. Lean away from impact.**
- 4. Lean forward.**

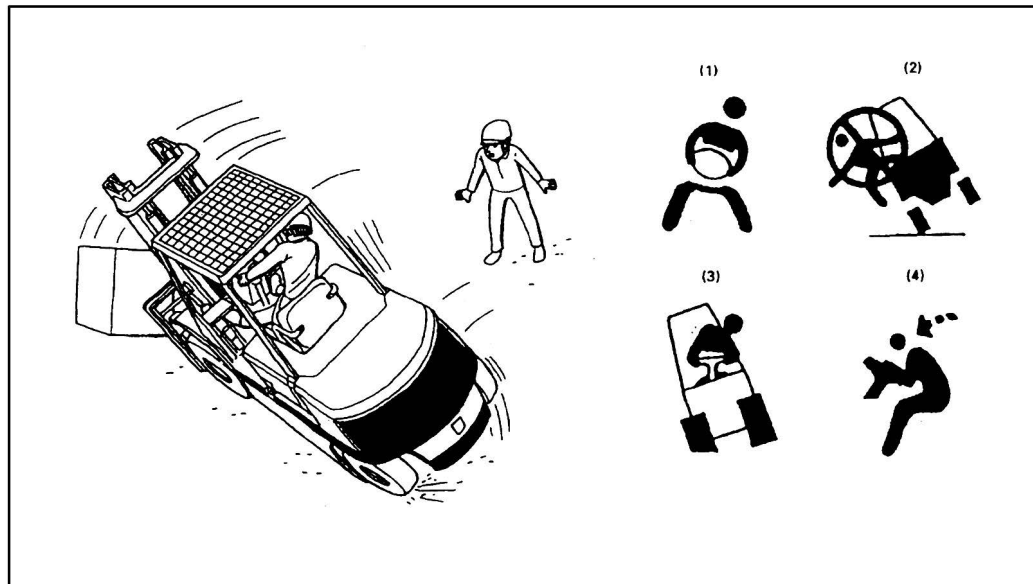

REFUELING

Diesel Engine Equipped

! WARNING

- Explosive fumes may be present during refueling.
- Do not smoke in refueling areas.
- Forklift trucks should be refueled only at designated safe locations. Safe outdoor locations are preferable to those indoors.
- Stop the engine and get off the forklift truck during refueling.

NOTICE: DO NOT allow the forklift truck to become low on fuel or completely run out of fuel. Sediment or other impurities in the fuel tank could be drawn into the fuel system. This could result in difficult starting or damage to components.

Fill the fuel tank at the end of each day of operation to drive out moisture laden air and to prevent condensation. DO NOT fill the tank to the top. Fuel expands when it gets warm and may overflow.

1. Park the forklift truck only at a location designated safe.

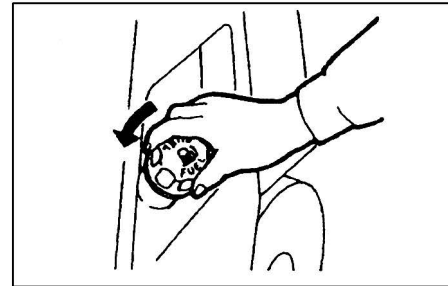

2. Open the filler cap.
3. Fill the fuel tank slowly. Close the filler cap. If spillage occurs, wipe off excess fuel and wash down the area with water.

Daily pre-operation Inspection

1. Check all the exposed connectors and the tightness of all the fasteners;
2. Check the leakiness of the hydraulic system and the fullness of fuel tank .Also check whether the lubricating oil is enough;
3. No smoking while checking the fuel system and battery. No fueling when the engine is still at work.
4. Check the tyre pressure whether is normal
5. Check the cooling system whether is normal
6. Check the electrical system whether have bad connect or short circuit
7. Check the free trip of the pedal and whether all the handle lever are return to neutral
8. Check the steering and braking system, insure agility and reliability.
9. Check the mast, make sure the mast can be lifted and tilted freely.

New Forklift Truck Break-In

Correct break-in is important for operation and long life of your truck. The first 100 service hours of operation is the break-in period for your truck.

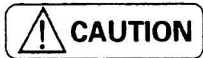

1. If the truck cannot be put to work immediately, or the operation is light and slow, break in the truck under a simulated working condition.
2. Operate the truck under a lighter load and lower speeds than normal.
3. Change oils and relubricate at shorter intervals than normal.

Before Starting Engine



1. After starting the engine, BE SURE to run it at idle speeds with no load for about 5 minutes. During this time, check all the OK Monitor indicator lights. AVOID long periods of idling. This may cause cylinder wall glazing and prevent the piston rings from seating properly. DO NOT pump the accelerator pedal and DO NOT REV up the engine. This may cause cylinder wall scuffing and scoring.
2. Try NOT to drive the truck continuously at the same speeds as the parts tend to better adjust themselves to other parts if various speeds are used.
3. ALSO, try NOT to make severe brake applications to allow the brake linings to seat against the brake drums.
4. Carefully check on and around the truck for loose bolts and nuts. Retighten them as needed.

OPERATION

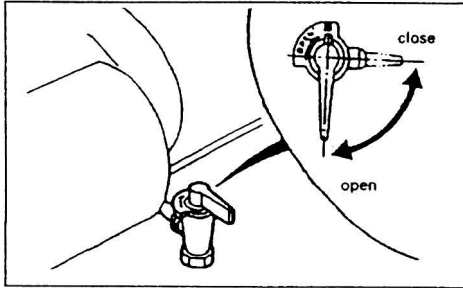

Open the fuel shutoff valve.

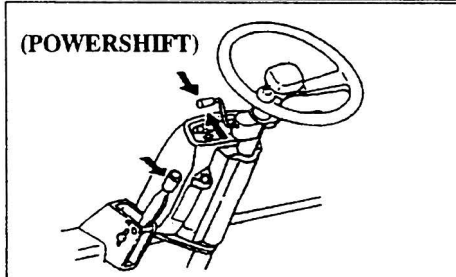
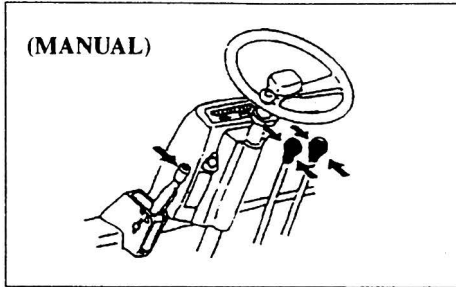

- Pull the parking brake lever.
- Be sure the direction lever is in the NEUTRAL position.
- The engine will not start unless the direction lever is in the NEUTRAL position.
- If the engine stalls, place the direction lever in the NEUTRAL position; turn the key to the O (OFF) position; and turn it to the Ⓜ (START) position to start the engine.



(MANUAL)

NEVER start the engine unless the direction lever is in NEUTRAL position as this may cause the truck to move suddenly.



Be sure to fasten the seat belt before operating the truck.

Remember, the belt will not restrain you in an accident if it is not fastened properly.

OPERATION

◆ Starting Diesel Engine

• Engine Cold in Cool Weather

Turn the key to the I (ON) position and wait until the heater plug indicator goes out.

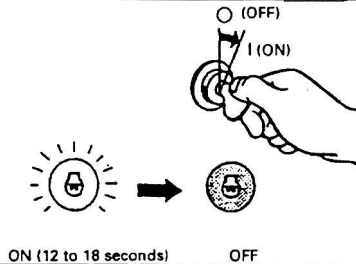

Depress the accelerator pedal all the way and hold in this position.



Turn the key to the Ⓞ (START) position to crank the engine (no more than 10 seconds at a time).



- Release the key when the engine starts.
- Release the accelerator pedal.



• Engine Warm

You do not need to turn the key to the I (ON) position and preheat the engine or depress the accelerator.



If the engine won't start:

Turn the key to the Ⓞ (OFF) position and wait for about 30 seconds before re-anking the engine.

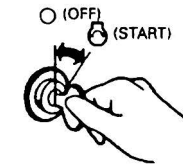

If the engine won't start, see the topic, **If Engine Won't Start.**

OPERATION

Engine Won't Start

Consult your Feeler Forklift Truck Dealer if the engine still fails after you have attempted several times.

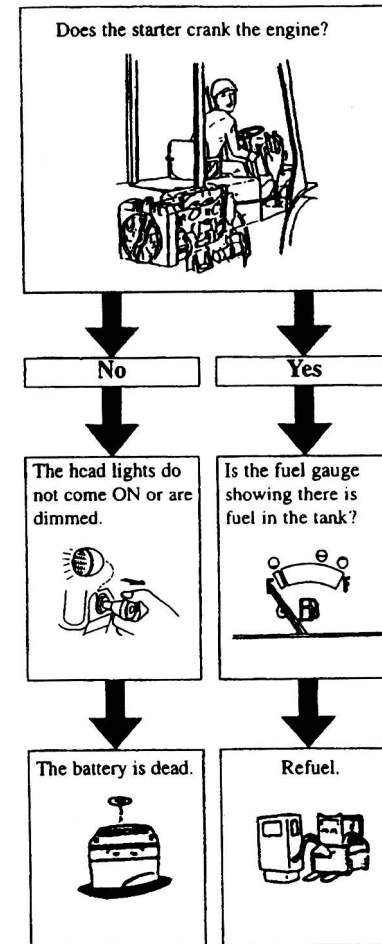
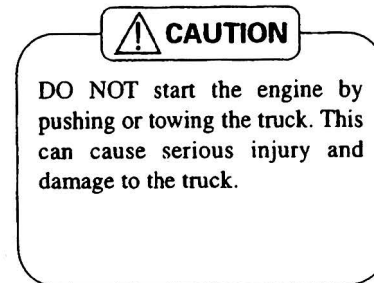
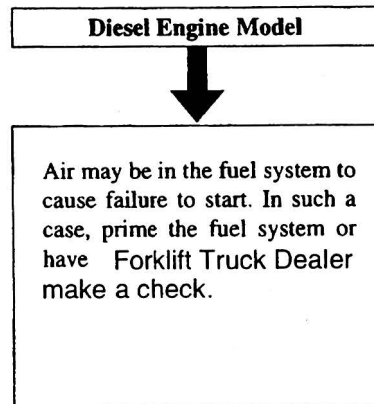

OPERATION

◆ Forklift Truck Operation (MANUAL)

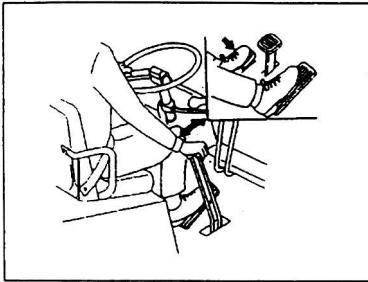

1. Depress the clutch pedal fully. Move the direction lever to FORWARD or REVERSE position.

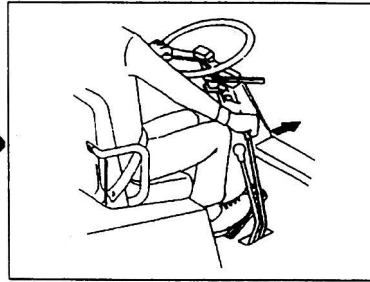

2. Move the gearshift lever to 1ST SPEED position.

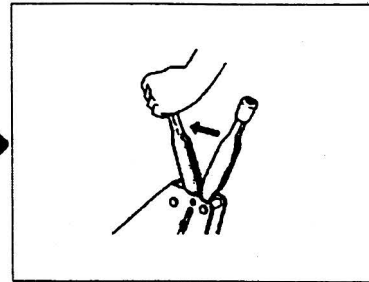

3. Push the parking brake lever.

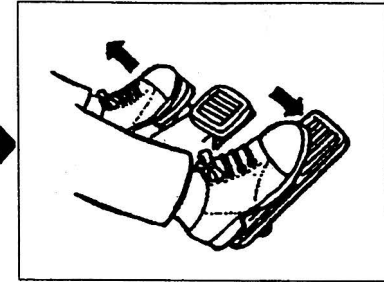

4. Gradually depress the accelerator pedal while releasing the clutch pedal.

(POWERSHIFT)

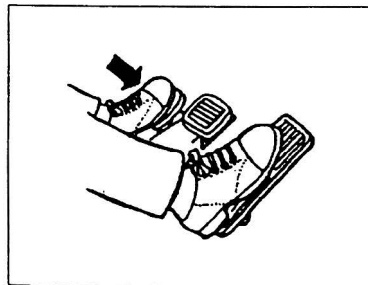

1. Depress the inching pedal all the way.

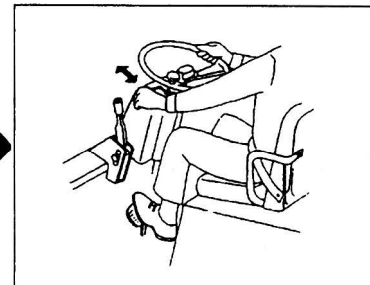

2. Move the direction lever to FORWARD or REVERSE travel position.

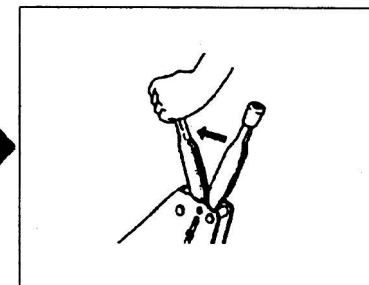

3. Push the parking brake lever.

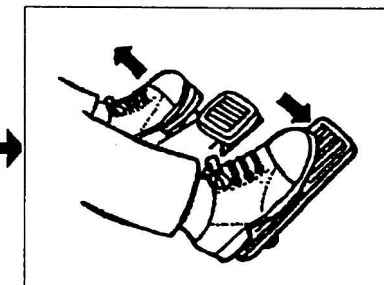

4. Gradually depress the accelerator pedal while releasing the inching pedal.

OPERATION

**• Changing Speed
(MANUAL)**

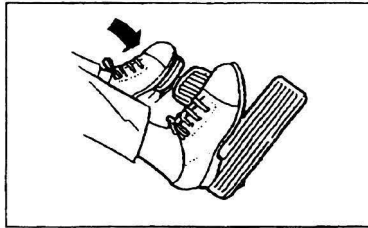

1. Release the accelerator pedal and, at the same time, depress the clutch pedal.

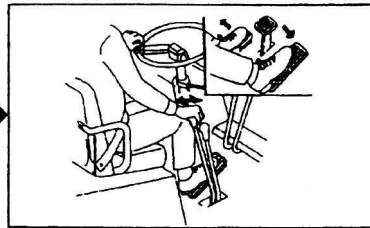

2. Move the gearshift lever from 1ST SPEED to 2ND SPEED position or from 2ND SPEED to 1ST SPEED position.

**• Changing Direction
(MANUAL)**

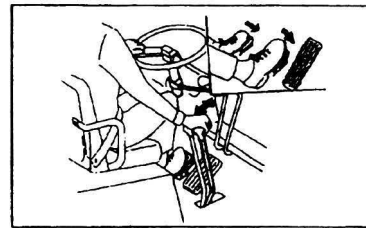

BE SURE to come to a complete stop when changing direction.



BE SURE to watch for people or hazards in the direction of travel.

⚠ CAUTION

Before operating the speed selector, **BE SURE** to come to a complete stop.

3. Depress the accelerator pedal while releasing the clutch pedal.

(POWERSHIFT)

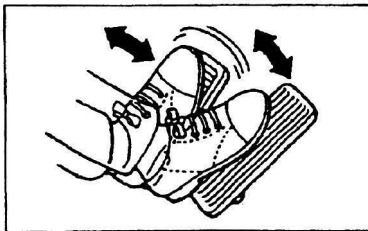

Use the accelerator pedal to increase travel speed. Use the brake pedal to slow down.



NEVER move the direction lever to **NEUTRAL** position during traveling. This causes the engine to overspeed.

⚠ CAUTION

Directional changes faster than stated will cause premature damage to the driveline. For greater operator safety and maximum service life of driveline components, it is recommended the operators bring the truck to a complete stop before changing direction.

(POWERSHIFT)

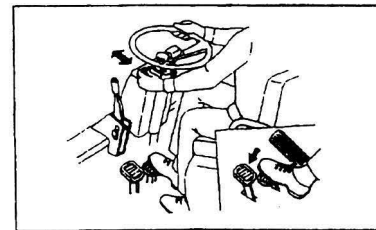

BE SURE to come to a complete stop when changing direction.



OPERATION

• Operating Techniques

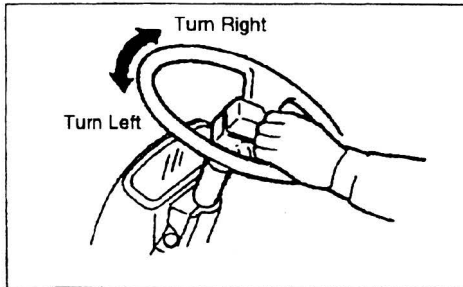

When advancing, turn the steering wheel in the same direction, as the turning direction. When handling loads, stop the truck and move the tilt and lift control levers with the right hand.

• Steering (Turning)

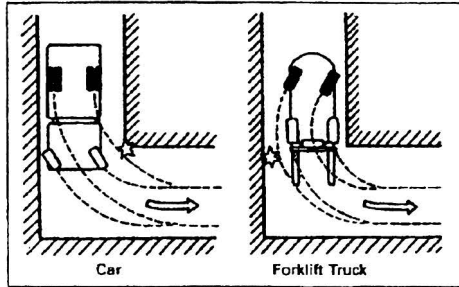

A forklift truck is different from most other vehicles because it is steered by the rear wheels. This causes an exaggerated tail swing.

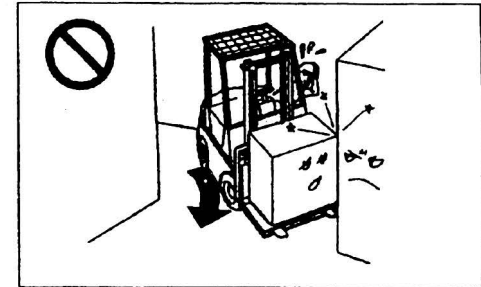

1. When working in close quarters, drive more slowly when making turns.
2. Start the turn as close to the inside corner as the tail swing will permit.

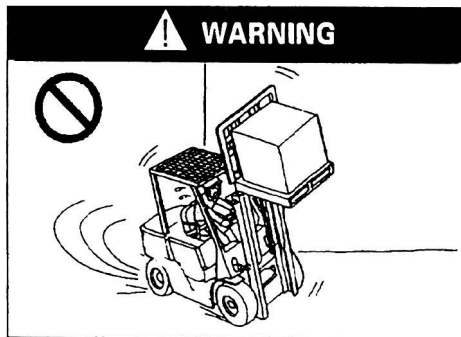

Turning with the forks elevated, with or without a load, can cause a tipover.

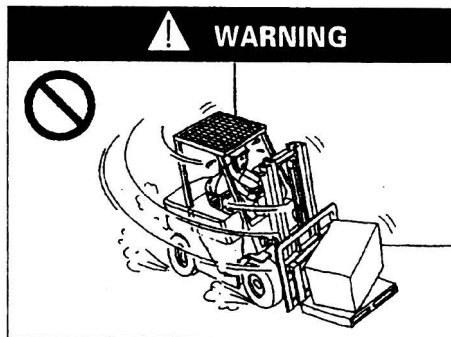

Turning at high speeds, with or without a load, can also cause a tipover.

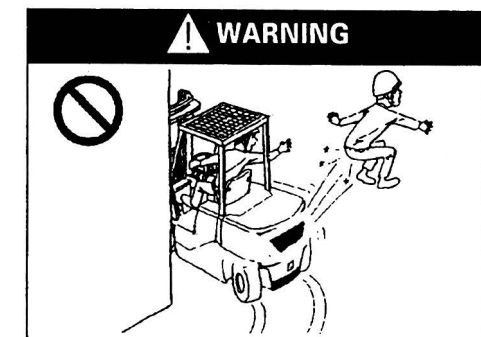

Be aware of tail swing distance. Be sure the tail swing area is clear, before turning, to avoid injury to pedestrians.

OPERATION

• Inching

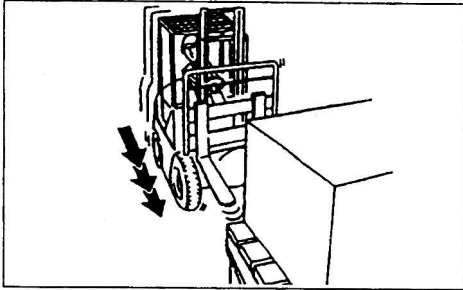

The purpose of the inching pedal is to provide precise forklift truck inching control at very slow travel speed and high engine rpm. You can move your truck slowly while maintaining the engine speed by varying the position of the inching pedal. Use this pedal when approaching the load and when loading and unloading.

CAUTION

DO NOT "ride" the inching pedal. This produces a partly disengaged condition that will result in premature brake lining wear.

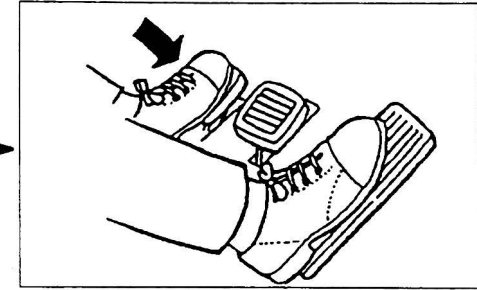
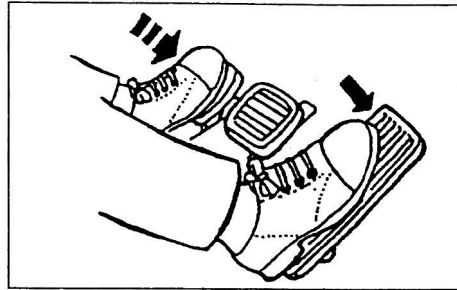

1. Stop ahead of the load platform, lock the parking brake lever, set the direction lever to NEUTRAL, place the mast vertically, and raise the fork to the height of the pallet insertion openings.
2. Depress the inching pedal all the way, move the direction lever to FORWARD, and release the parking brake.
3. Gently depress the accelerator pedal.

4. When the left foot is slowly taken off the inching pedal, the fork lift will advance slowly.
5. Insert the fork slowly, taking care it does not hit the pallet.
6. Stop after inserting the fork until the root of the fork comes into light contact with the pallet.

OPERATION

◆ Stopping Forklift Truck (MANUAL)

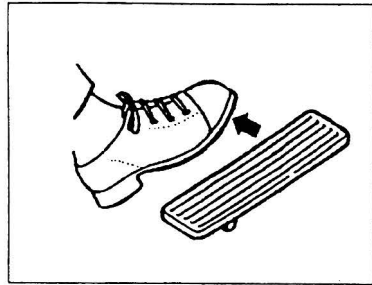

1. Release the accelerator pedal.

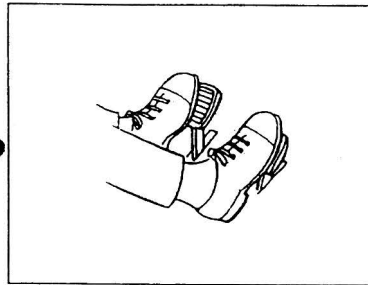

2. Depressed the brake pedal and, just before the truck stops, depress the clutch pedal.

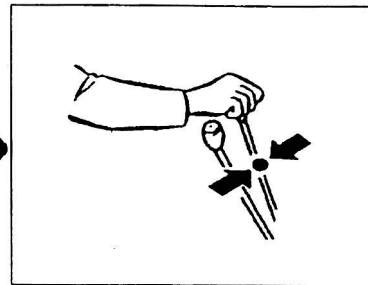

3. After the truck has been stopped, move the direction lever to NEUTRAL position.



Avoid sudden stops. This can cause the load to fall off the forks or the truck to tipover.

(POWERSHIFT)

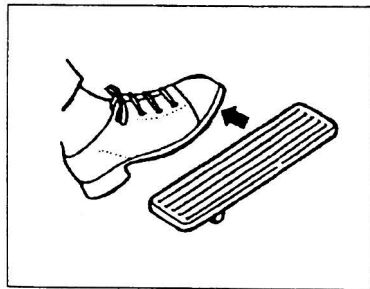

1. Release the accelerator pedal.

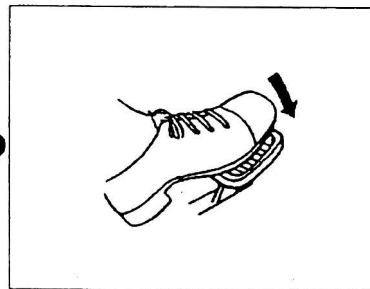

2. Depress the brake pedal.

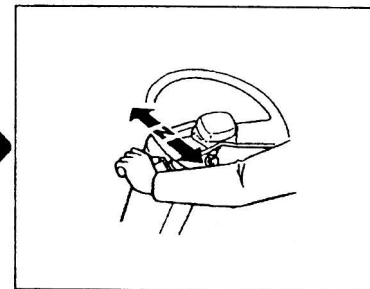

3. Move the direction lever to NEUTRAL position.

OPERATION

Parking Forklift Truck (After stopping)

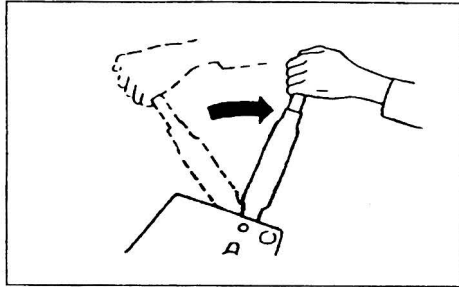

Pull the parking brake lever all the way.

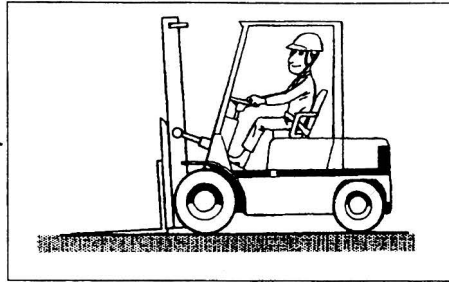

Tilt the mast forward just a little and lower the forks to the floor until the fork tips touch the floor.

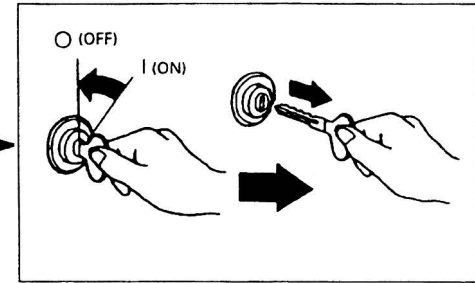

Turn the key back to the ○(OFF) position to stop the engine. When leaving the truck, **BE SURE** to remove the key.

WARNING

Park safely

- Select a hard level surface.
- **BE SURE** to park in a parking lot if available.
- If the lift mechanism is disabled and the forks cannot be lowered to the floor, attach a warning tag to the tip of the fork and position the forks away from pedestrians.

Get off safely

- Get off after the truck has come to a complete stop and the above procedure has been followed.
- **NEVER** jump off.

POST-OPERATION INSPECTION AND STORAGE

■ Post-operation inspection

After work clean the outside and inside of the vehicle and check the following:

1. Check any abnormal points found during operation.
2. Check for visible damage and missing bolts.
3. Check for fluid leakage.
4. Check tires for abnormalities.
5. Check bolts and hydraulic piping for looseness.

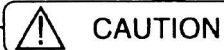

- ◆ Park a disabled machine safely.
- ◆ Repair defects, if any, on the same day.
- ◆ Always make the forklift truck ready to operate at any time.

■ Daily Storage

Pay attention to the following points when storing the forklift truck:

1. Park at a dry and flat place.
2. Pull on the parking brake without fail.
3. Tilt the mast to the vertical position and lower the fork to the ground.
4. Turn the key switch OFF and remove the key.
5. Move the lift lever and tilt lever back and forth 3 or 4 times to release the pressure remaining in the cylinder piping.

■ Long-term Storage

Pay attention to the following points in addition to those above when storing the forklift truck for a long time:

1. Disconnect the battery plug to prevent discharge and store the vehicle at a dark place.
2. Apply anti-rust grease to shafts, rods and other exposed parts.
3. Cover the breather and other openings where moisture may enter.
4. Cover the entire vehicle with a sheet or the like.
5. Lubricate all lubrication points.
6. Set air pressure of all tires to the specified value.

POST-OPERATION INSPECTION AND STORAGE

- 7. Completely bleed the water and hydraulic oil .
- 8. Make the vehicle ready to operate at least once a week and check all operations.
- 9. Measure the specific gravity and level of the battery electrolyte at least once a month. Charge the battery or replenish water as required.

■ Pre-operation Inspection

	NO.	Check Item		NO.	Check item
Overall	1	Abnormality found on the previous day	Mast	12	Damage and operation of mast
	2	Oil leak from gear cases, cylinders and hoses		13	Damage of back rest and head guard
	3	Location to specified positions		14	Installation of forks and attachment
	4	Damage, wear and air pressure of tires		15	Chain tension
	5	Loose hub nuts		16	Looseness of tilt cylinder rod
	6	Abnormal sound		17	Hydraulic fluid level
Main body	7	Accelerator pedal operation	Gauges	18	Operation of direction indicator
	8	Brake pedal operation		19	Operation of horn
	9	Brake fluid level		20	Operations of lamps and gauges/meters
	10	Parking brake performance		21	Dirt and angle adjustment of rear-view mirror
	11	Play and follow-up performance of steering wheel	battery	22	Secure connection of battery plug

OPERATING TECHNIQUES

Working on Grades

The Engine Stalls on a Grade

Starting on a Grade

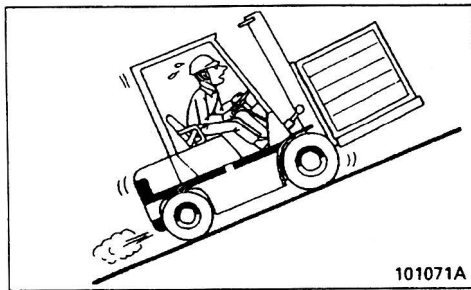

1. Apply the parking brake to hold the truck and lower the forks to the ground.
2. Depress the clutch pedal, move the gearshift lever to NEUTRAL position and start the engine.
3. Move the gearshift lever to 1ST. SPEED position.
4. Raise the forks or load to the safe travel position.
5. See that the goods near to the shield

which can fix and protect the goods when slope down and up. And the shield can be a surveyor's rod when the goods is lifting to the highest point

(Safe Travel Position)

- Keep the forks or the load at a safe travel height, which is 15 to 20 cm (6 to 8 in.) from the ground.
- Tilt the mast back more than 6° when the truck is empty. Tilt it all the way back when the truck is loaded.

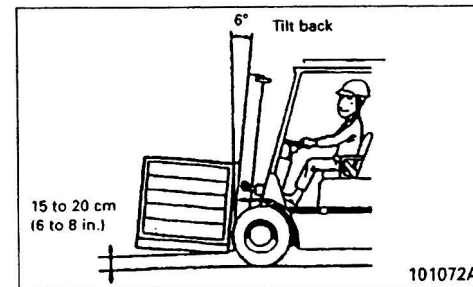

5. Depress the accelerator pedal while gradually releasing the clutch pedal. As soon as the clutch is engaged, gradually release the parking brake lever.

OPERATING TECHNIQUES

Traveling on a Grade

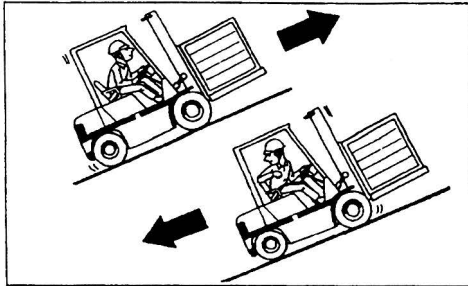

Travel forward up a grade and in reverse down a grade when the truck is loaded.

WARNING

- **DO NOT** continuously use the brake pedal alone. This can result in brake failure and an accident.
- **DO NOT** use the inching pedal when traveling down a grade. This prevents the engine from acting as a brake.
- **DO NOT** move the direction lever to **NEUTRAL** position when traveling down a grade.

Stopping on a Grade

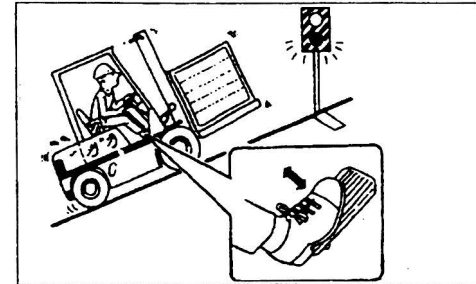

CAUTION

Depress the brake pedal when you have to bring the truck to a stop on a grade. **DO NOT** hold the truck by depressing the accelerator pedal. This can cause clutch plate wear.

When traveling up or down a steep grade:

1. **DO NOT** stop the engine.
2. **DO NOT** make any turns.
3. **DO NOT** travel across the grade.

SPECIAL SITUATIONS

◆ Care in Hot Weather

• Fuel Oils and Lube Oils

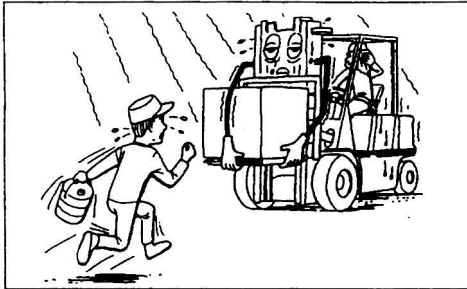

Use fuel oil, engine oil and gear oil to fit the ambient temperatures.

• Battery

In hot, dry weather, check the battery cells for proper electrolyte level more often than in cold weather. Add distilled water whenever the level is low.

• Engine Coolant

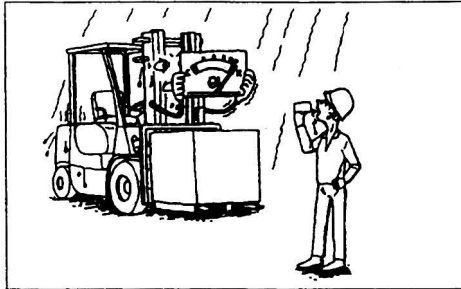

Coolant evaporates rapidly and the engine is likely to get overheated when the truck is operated continuously or on a grade. During such an operation, observe the engine coolant temperature gauge for symptoms of overheating.

⚠ CAUTION

Be careful **NOT** to have scalding hot coolant or steam blow out of the reserve tank.

◆ Care in Severe Dust

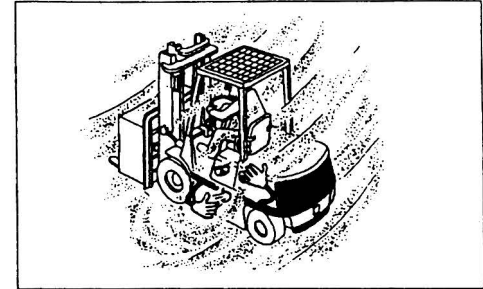

Check and service the air cleaner element more frequently.

Check the radiator core more frequently for clogging or trash build-up. Clean or wash the truck as necessary.

TROUBLESHOOTING

3. Gears in the transmission can not be engaged

Reason & Method
<ol style="list-style-type: none">1. The gears were over worn. It should be changed.2. The spring of ball is too soft. Just change it.3. Gearshift fork was worn out. It should be changed or welded.4. The clutch can not separate completely. Just adjust it.

4. Jumping gear of the transmission

Reason & Method
<ol style="list-style-type: none">1. The gears were over worn. It should be changed.2. The spring of ball is too soft. Just change it .3. Gearshift fork was worn out. It should be changed or welded.

5. Transmission was louder

Reason & Method
<ol style="list-style-type: none">1. Upon the middle shaft, front bearing and back bearing are too loose.2. The gears were over worn. It should be changed.3. The middle shaft was worn out. Just change it.4. The lubricants on the gears was too little or too thin. Please add some or change to add a new type of lubricant.

6. Abnormal noise in drive axle.

Reason & Method
<ol style="list-style-type: none">1. The circular cone gear was worn out or the clearance was too wide.2. The crossing shaft of the differential worn out. Just

TROUBLESHOOTING

change a new one.
3.The circular cone roller bearing was worn out or loose.
Just change a new one or adjust the bearings.

7.The main reduction of the drive axle was too hot

Reason &Method
1.The bearings of the drive gears are too tight.Just readjust the bearings pretightening force. 2.The lubricants of the gears are too much or too little. If the oil starts to output from the plug, it is the right volume.

8.Turn sharply or can not turn at all

Reason &Method
1.The safe load pressure of the shunt valve which keeps a steady volume is too low. 2.There maybe air among the oil pipes in the turning system,Just drain the air off. 3.The return function of the turning unit is out of work, and the elasticity of the positioned spring is not enough and is torn out.You should change a new one 4.The turning angle of the steering tire is not right. Adjust the turning angle (inside and outside). 5.The body of the steering axle is out of shape.Should be repaired. 6.The tilting cylinder has over-leakage inside. You should check and change the seal and piston.

9.Floating when turning and stringing of the tire

Reason &Method

TROUBLESHOOTING

- 1.The volume when turning is over. Just adjust the volume of the shunt valve and adjust the bolts.
- 2.The lever to turning connected not tightly. Pinch it tightly.
- 3.The nut to fix the wheel is too loose, or the bearing of the wheel shell is too loose .Please adjust and change a new one.

10.The brake by foot is out of work

Reason &Method
1.The part of auto-adjustment is out of work. And the clearance between the brake drum and the friction plate of the brake unit is too wide or is out of the position.Just adjust and correct.
2.The master cylinder and the liquid for input and output are out of work. Have to dismantle them to check and repair.
3.The cup piston is blocked because it is bloated. Change a new cup piston.
4.Maybe air inside or leak. Just drain the air off and repair the leak part.
5.The friction of the bake plate is worn out. Change a new one.
6.The two wheels can not brake at the same time. Please adjust the clearance and drain the air inside the pipe.
7.Too much free route of the brake pedal.Just to adjust it.
8.The brake loses the function of force-generation.You should check and adjust.

TROUBLESHOOTING

11.The foot brake heat

Reason &Method
<ol style="list-style-type: none">1.The part of auto-adjustment is out of work. And the clearance between the brake drum and the friction plate of the brake unit is too wide or is out of the position. Just adjust and correct.2.The spring of the brake was too weak. Just change a new one.3.The cup piston is blocked because it is bloated. Change a new cup piston.

12.The hand brake is out of work

Reason &Method
<ol style="list-style-type: none">1.The clearance between the brake drum and the friction plate of the brake unit is too wide or is out of the position. Just adjust and correct.2.The spring of the brake was too weak. Just change a new one.3.The strut is too loose. Please adjust the pretightening.4.The strut is blocked. You should make it to operate flatly and smoothly.

13.It is difficult to load or can not load at all.

Reason &Method
<ol style="list-style-type: none">1.The gear of the pump and pump are mutually worn and torn seriously. And the clearance is too wide. You can change a new gear or pump.2.The piston ring of the lifting cylinder has been worn and torn and also over-leakage. You should change a new piston ring.

TROUBLESHOOTING

3. Multi-valve and the spring of the safe valve are out of work. You should change a new spring.
4. Mutual wear and tear between the control lever of the multi valve and the valve lead to over-leadage. You should plate chromium on the lever.
5. Leakage among the valves. You should reconfigure after grinding, then tighten the screw in in-sequence.
6. Hydraulic pipeline leaks, should connect the nut closely. And check whether the nut connects the sealed liner was damaged or not.
7. The temperature of the hydraulic oil is too high or the hydraulic oil is too thin. Maybe the flow is insufficient. In this case, you should change the hydraulic oil which is stipulated to conform to or reduce the oil when parking. Find out why the temperature is so high.
8. Overload, please operate according to the regulation.
9. The slide valve of the shunt valve was blocked. Just dismant the shunt valve to repair.

14. The mast and the fork shelf can not tilt freely itself.

Reason & Method
1. The wall of the tilting cylinder and the seal ring are worn excessively. Just change the seal ring or the cylinder.
2. The spring of the lever on the multi-valve is out of work. Just change a new one.

15. The fork shelf can not lift and tilt flexibly.

Reason & Method

TROUBLESHOOTING

1. The piston blocks the casing wall or the cylinder rod is crooked. Just change the damaged one.
2. Jar is too dirty and it is sealed too tightly. You should wash it and adjust the sealing cover to a proper degree.

16. The alarm light for charge can not go off after the engine started.

Reason & Method

- | |
|--|
| <ol style="list-style-type: none">1. The voltage of the engine is not stable. Just repair it or change a new one.2. The adjustor has stoppage. Just repair it or change a new one |
|--|

17. Light kit—head light, turning light, rear light can not stay bright.

Reason & Method

- | |
|---|
| <ol style="list-style-type: none">1. The plug can not connect well. Just tighten the plug.2. The start switch is damaged or can not connect well. Just change a new one.3. The bubble is damaged. Just change a new one.4. The connection is not well. Please tighten the bolts. |
|---|

18. The deficiency of the pump pressure.

Reason & Method

- | |
|--|
| <ol style="list-style-type: none">1. The seal ring for deal with the tighten parts is worn and torn, which lead to leakage. Just change a new one.2. The seal ring of the oli cap inside, just change a new one.3. The surface of the bearing was worn and torn. Changing!4. The gear was worn and torn. Just change a new oil pump.5. The rotational direction is wrong. Please correct it.6. The hydraulic oil sneaks into the air and spumes, and the pipe leak. Mabe there is also deficiency hydraulic oil. You should clear up air and repair the leak point. |
|--|

TROUBLESHOOTING

◆ Changing a Tire



DO NOT attempt to change the tire with the truck loaded. Injury and/or damage may result.



BE SURE no one is on the truck when raising the front or rear tires.

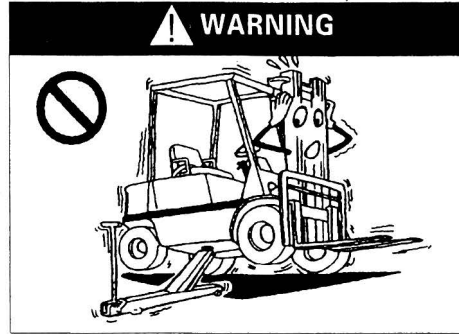

Stop raising the truck when the tire clears the ground. DO NOT raise the truck more than necessary.



DO NOT place any part of your body under the truck. SECURELY SUPPORT the truck with blocks after jacking it up.

⚠ WARNING

- Consult your Mitsubishi Forklift Truck Dealer for proper tire changing procedure.
- Changing of tire and adjustment procedure must be made by a trained mechanic or dealer personnel.
- Perform all maintenance in the factory with proper equipment.

TROUBLESHOOTING

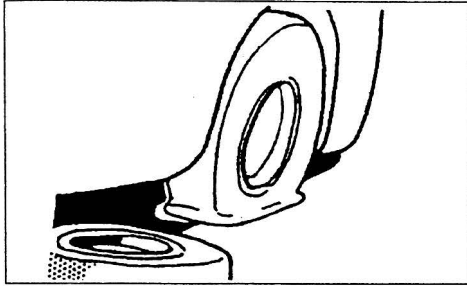

1. Park the truck on level ground with parking brake applied, transmission in neutral, forks lowered and engine stopped.

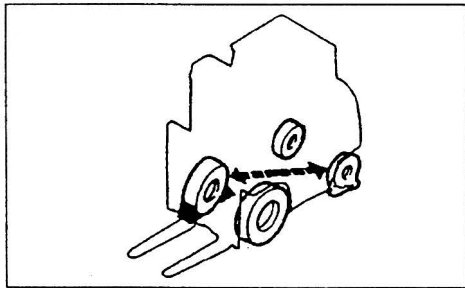

2. Prepare tools, jack and wheel blocks.

Jack Capacities

5
5 tons minimum

3. Block the diagonally opposite wheel.

• Single Tire

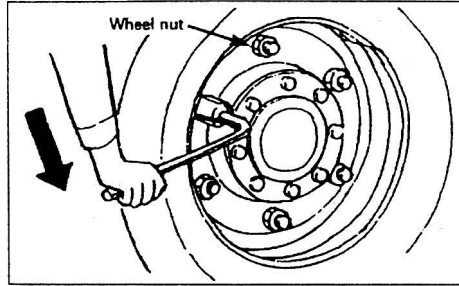

To Remove Tire

1. Loosen the wheel nuts about two rotations.
NOTICE: Only loosen the wheel nuts. DO NOT remove them.
2. Position the jack under the truck at the specified jacking point.
3. Raise the truck by operating the jack until the tire just clears the ground.

To Raise Front Tire

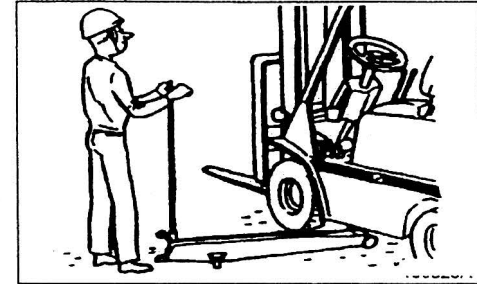

Position the jack under the frame and raise the truck until the front tire clears the ground. Next, place stands or blocks of wood on both sides under the frame to support it.

Other Method

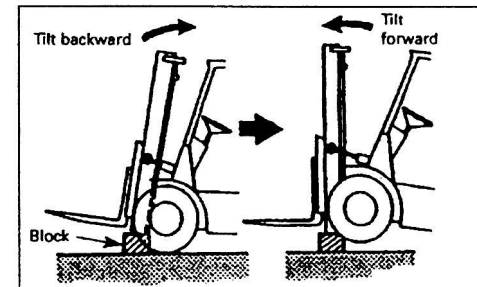

Tilt the mast all the way back, place blocks under the mast, and tilt the mast forward.

TROUBLESHOOTING

Changing Tire

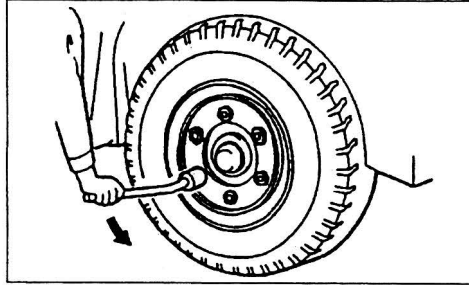

To Remove Tire

1. Loosen the wheel nuts about two turns.

NOTICE: DO NOT remove the wheel nuts. ONLY loosen them.

2. Position the jack under the truck at the specified jacking point.
3. Raise the truck by operating jack until the tire just clears the ground.

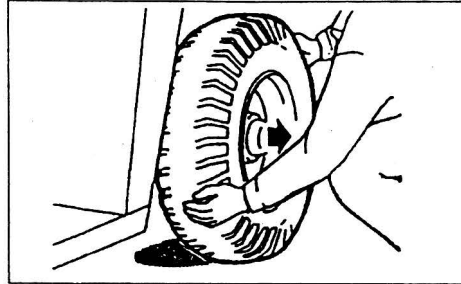

4. Remove the wheel nuts by hand.
5. Firmly grip the tire with both hands, and remove it from the truck.

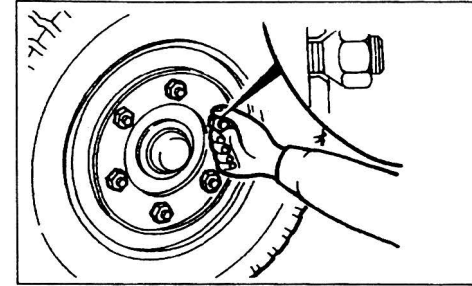

To Install Tire

1. Tighten the wheel nuts just enough to hold the tire without rattling, making sure the clamping surface of each nut comes in full-face contact with the counterbore of the wheel disc.

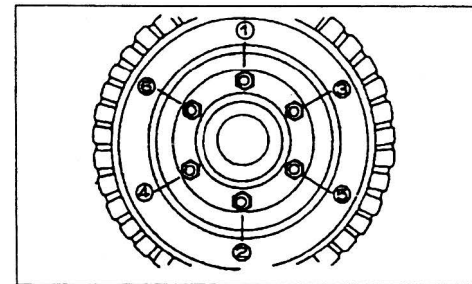

2. Lower the truck until the tire touches the ground. Tighten the wheel nuts, in two or three steps, to the specified torque. Each of the steps must follow the tightening sequence shown above.

CAUTION

When removing the tire, be careful not to strip the wheel bolt threads on the edges of the bolt holes in the rim.

MAINTENANCE

For periodic inspection and periodic change of parts, however, rely on the expert knowledge of the factory-trained servicemen, and the service facilities at your Mitsubishi Forklift Truck Dealer's workshop. Always use the Forklift genuine parts for replacement parts.

Maintenance Schedule

As the operator, you are responsible for the performance of daily pre-start inspection. You are also responsible for those items listed under **Every 50 Service Hours or Weekly, Whichever Comes First** to keep your forklift truck in proper working condition.

Periodic inspection time intervals	<ul style="list-style-type: none"> • One month after delivery of a new truck • Every 200 service hours or monthly, whichever comes first • Every 1200 service hours or 6 months, whichever comes first • Every 2400 service hours or 1 year, whichever comes first
------------------------------------	--

Every 10 Service Hours or Daily , Whichever Comes First

Item	Service
Damaged or faulty operation found the day before	Check
Oil, fuel or coolant leaks	Check
Lights	Check
Load backrest extension	Check
Tilt cylinder socket bolts	Check
Overhead guard	Check
Assist grip	Check
Accelerator pedal	Check

Every 10 Service Hours or Daily (Pre-Start), Whichever Comes First, continued

Item	Service
Brake pedal	Check
Inching pedal	Check
Clutch pedal	Check
Parking brake lever	Check
Seat belt	Check
Seat adjustment	Check
Horn	Check
Steering wheel	Check movement
Amount of fuel	Check
Stop lights	Check
OK monitor	Check
Lift chains	Check/adjust
Engine	Check
Clutch	Check
Service brakes	Check
Backup lights	Check
Engine crankcase	Check oil level
Engine coolant	Check coolant level

MAINTENANCE

Every 10 Service Hours or Daily (Pre-start), Whichever Comes First, continued

Item	Service
Hydraulic oil	Check oil level
Service brakes	Check fluid level
Clutch oil	Check oil level
Wheel nuts	Check
Tire and rims	Check
Mast and forks	Check
Battery	Check electrolyte level

Every 50 Service Hours or Weekly, Whichever Comes First

Item	Service
Air cleaner	Clean/inspect
Alternator drive belt	Check/adjust
Mast supports	Lubricate

One Month After Delivery of a New Truck

Item	Service
Hydraulic tank return oil filter	Change
Fuel filter—Diesel	Change

Every 200 Service Hours or Monthly, Whichever Comes First

Item	Service
Wheel nuts	Retighten
Powershift transmission	Check oil level
Engine crankcase—Diesel	Change oil and filter

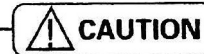

Improper disposal (in drainage or ground, burning, etc.) of waste battery and oil generated through the inspection may pollute the surrounding (water, soil or atmosphere). This may be banned by law.

MAINTENANCE

Every 200 Service Hours or Monthly, Whichever Comes First, continued

Item	Service
Mast strip roller surfaces	Lubricate
Lift bracket side rollers	Lubricate
Lift chains	Lubricate/ inspect
Tilt socket pins	Lubricate
Brake pedal	Lubricate
Rear axle center pins	Lubricate
Tilt cylinder pins	Lubricate
Fuse	Check
Drag link end	Lubricate
Bellcrank pin	Lubricate
King pins	Lubricate
Front axle support	Lubricate
Change levers	Lubricate
Control valve	Check

 **CAUTION**

When check the safe valve, just to check whether the bolts are loosen or not, and whether there is any abnormal in the connection of the oil pipes. If any, please keep in touch with our sales service.

Every 1200 Service Hours or 6 Months, Whichever Comes First

Item	Service
Powershift transmission	Change oil/ wash strainer
Hydraulic system	Change return oil filter/wash strainer
Air cleaner	Change element
Fuel filter-Diesel	Change
Engine coolant	Change

Every 2400 Service Hours or 1 Year, Whichever Comes First

Item	Service
Hydraulic oil	Change
Service brake fluid	Change
Clutch oil	Change

MAINTENANCE

• Inching Pedal

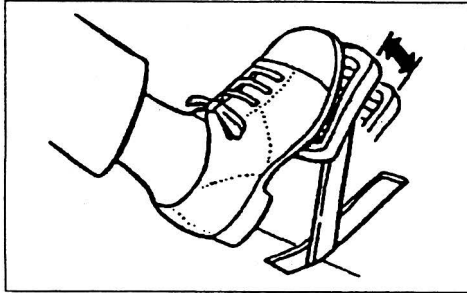

– Is the free play correct?

Correct Free Play

Unit : mm

All models	5
------------	---

• Assist Grip

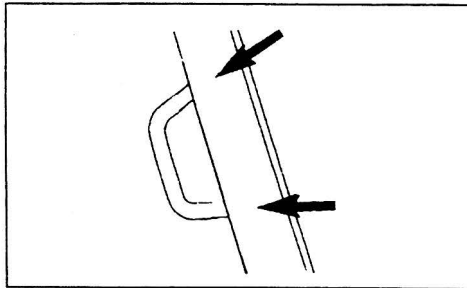

Inspect, and if necessary, tighten the screws of the assist grip.

• Overhead Guard

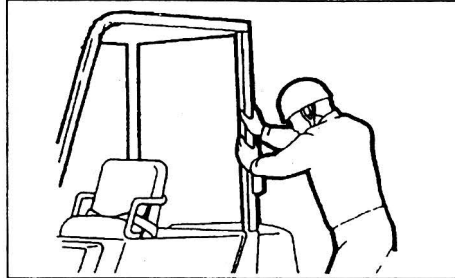

1. Check the front and rear overhead guard mounting bolts on each side.

2. Inspect overhead guard for bent or cracked sections.

3. If overhead guards are found in the safety devices, repair them immediately before starting operation.

• Tilt Cylinder Socket Bolts

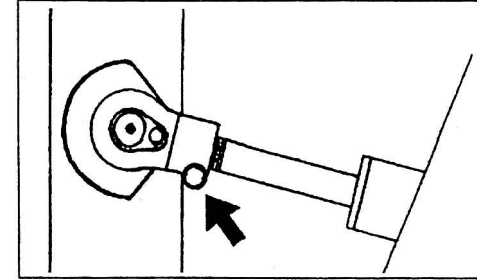

– Are the bolts tightened properly?

NOTICE: After retightening the bolt, put a mark across the bolt and tilt cylinder socket. This permits you to easily notice loosening of the bolt.

MAINTENANCE

- **Engine**

 **CAUTION**

Exhaust fumes can kill you! If it is necessary to start the engine in an enclosed area, make sure there is adequate ventilation. And you should check the regulation exhaust according to the Euro-criterion if you find that the exhaust was abnormal

Fire hazards! Clean up spillage of fuel, oil, or other flammable materials in the engine compartment. Know the location of all emergency devices (such as fire extinguisher, first aid kit, etc.) and how to use them.

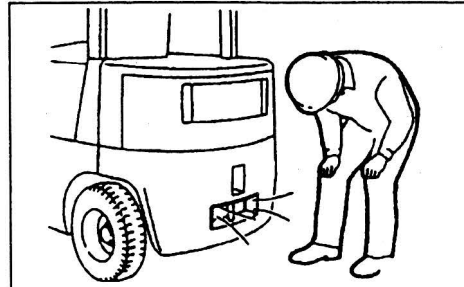

- Is exhaust smoke normal?
- Listen for abnormal noise or excessive vibration.

- **Clutch**

Does the flywheel clutch (MANUAL) or any transmission clutch (POWERSHIFT) grab or slip? The clutch grabs if the truck does not slow down when the clutch pedal (MANUAL) or the inching pedal (POWERSHIFT) is depressed. It slips if the truck does not pick up speeds when the accelerator pedal is depressed.

- **Service Brakes**

- Do the brakes apply and stop the truck properly—without dragging, chattering, squealing?

- **Backup Lights**

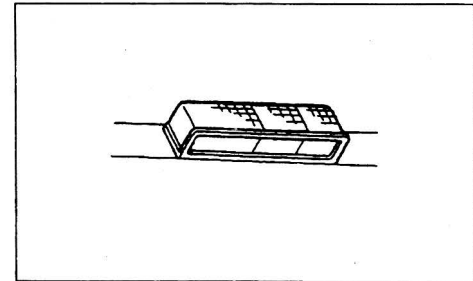

When you move the direction lever into REVERSE position:

- Do all backup lights come ON?
- Does the backup buzzer sound (if equipped)?

MAINTENANCE

• Engine Crankcase Check Oil Level

CAUTION

Hot oil and components can cause serious injury. Do not allow hot oil or components to contact your skin.

Park the forklift truck with the forks lowered, parking brake applied, transmission in NEUTRAL, and the engine stopped.

- 1 . Raise the hood.
- 2 . Remove the dipstick and wipe it clean, then insert it all the way.

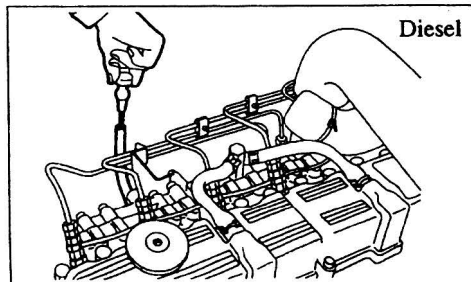

3. Maintain the correct level range on the dipstick.

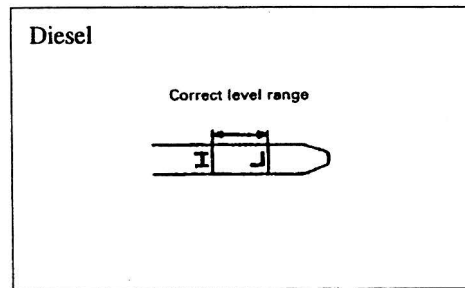

- 4 . Close and secure the hood.

Adding Engine Oil

CAUTION

- Perform the work on level ground.
- Clean the filler hole to prevent dirt from dropping into the engine.
- DO NOT overfill.
- Clean up spillage.

Remove the oil filler cap.

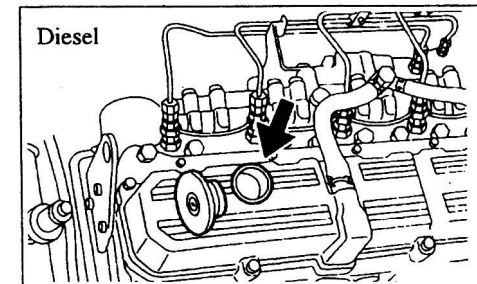

MAINTENANCE

• Hydraulic Oil Check Oil Level

CAUTION

Hot oil and components can cause serious injury. Do not allow hot oil or components to contact your skin.

1. Operate the forklift truck for a few minutes to warm the oil.
2. Park the forklift truck on a level surface, with the forks lowered, mast tilted back, parking brake applied, transmission in NEUTRAL and the engine stopped.
3. Remove the hydraulic tank filler cap

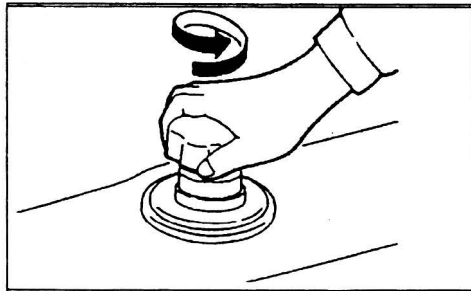

4. Add oil needed to raise it to the correct level range on the dipstick.

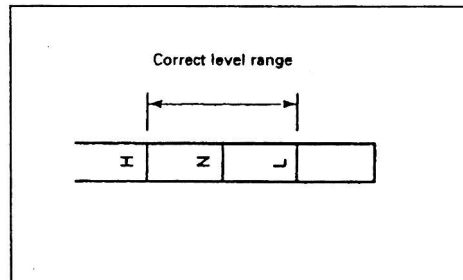
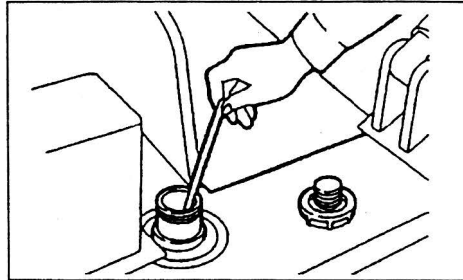

5. Put the hydraulic tank filler cap back on.
6. Check for oil leaks.
7. Close and secure the hood.

Adding Hydraulic Oil

1. Remove the hydraulic tank filler cap.

2.

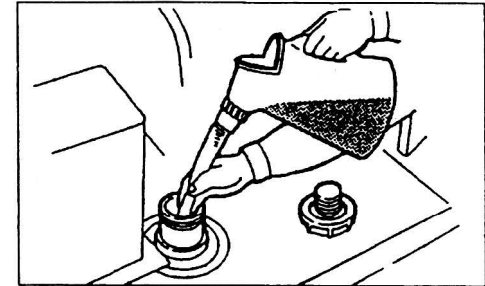

3. After adding oil, make sure the level is in the correct range on the dipstick.
4. Insert the dipstick into the filler port and install the hydraulic tank filler cap securely.
5. Close and secure the hood.

MAINTENANCE

Service Brakes Check Fluid Level



If the brake fluid in the reservoir decreases rapidly, the brake system is leaking.

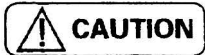

Before refilling the reservoirs, clean the ports to prevent dirt from getting inside the reservoirs.

Park the forklift truck with the forks lowered, parking brake applied, transmission in NEUTRAL, and the engine stopped.

1. Check the brake fluid level at the reservoir.

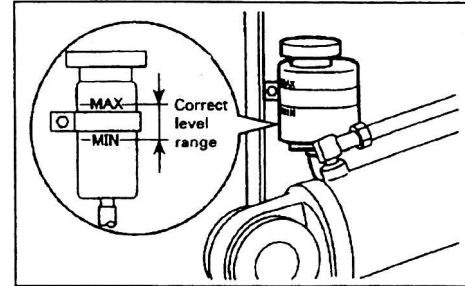

2. Maintain the brake fluid level between the MAX and MIN marks on the reservoir.

Adding Brake Fluid

1. Remove the reservoir cap.
2. Add brake fluid to the reservoir.
3. Put the reservoir cap back on.

MAINTENANCE

• Mast and Forks Check

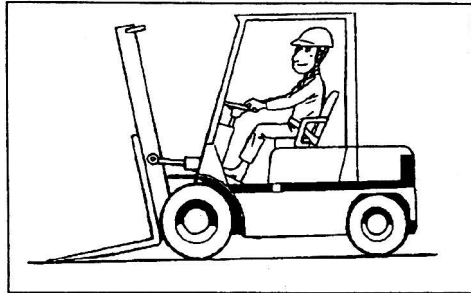

- Does the mast move up and down smoothly when you operate the lift control lever?
- Does the mast tilt forward and back smoothly when you operate the tilt control lever?
- Are there any oil leaks from the cylinders and hydraulic lines?

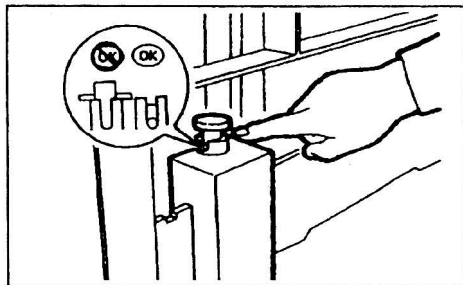

- Is the stopper properly engaged?

Are the forks free of distortion and cracks?
Are the welds of the hangers free of cracks?

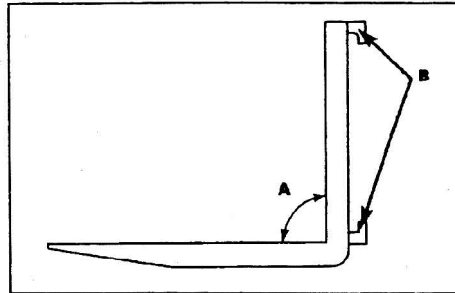

If the truck is being used to carry maximum capacity loads, the forks should be checked daily.

1. Carefully inspect the forks for cracks. Special attention should be given to the heel section A, all weld areas and mounting brackets B.

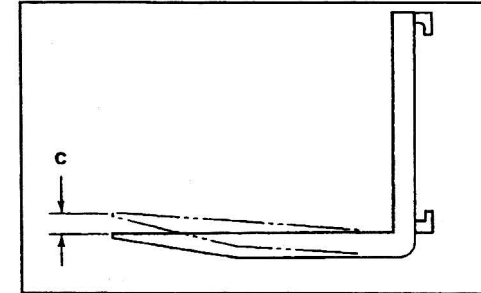

2. Check the difference in height of one fork tip to the other when mounted on the fork carrier. A difference in fork tip height can result in uneven support of the load and cause problems when entering loads.

The maximum allowable difference in fork tip elevation C is 5 mm for pallet forks. Replace one or both forks when the difference in fork tip height exceeds the maximum allowable difference.

MAINTENANCE

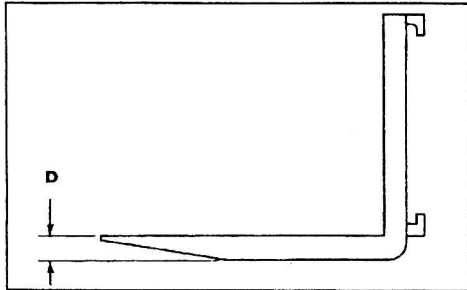

3. Check the fork blade D. The fork should be withdrawn from service if the thickness is reduced to less than the tolerant thickness.

Fork blade length may also be reduced by wear, especially on tapered forks and platens. Remove the forks from service when the blade length is no longer adequate for the intended loads.

• Battery Check Electrolyte Level

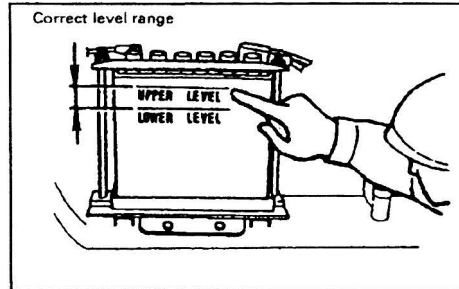

1. If the electrolyte level is low, remove the filler caps and add distilled water to the cells. Before removing the caps, clean the top of the battery.
2. After adding the water, tighten the caps securely.



If acid gets in your eyes, FLUSH THEM IMMEDIATELY WITH LARGE AMOUNTS OF WATER AND SEE A DOCTOR AT ONCE.

3. Using a battery hydrometer, check the specific gravity of the battery cells. Take the reading at eye level.

Specific gravity corrected to 20°C (68°F)	Battery condition
1.260 to 1.280	Fully charged
1.220 to 1.260	Three-fourths charged (to be recharged)
Below 1.220	Completely discharged (to be recharged and retested)

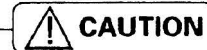

If distilled water has to be often added, have your Forklift Truck Dealer check the battery.

MAINTENANCE

◆ Every 50 Service Hours or Weekly, Whichever Comes First

You must read and understand the warnings and instructions contained in this manual before performing any operating or maintenance procedures.

• Air Cleaner

Clean and Inspect

⚠ CAUTION

Never service the air cleaner with the engine running.
Do not clean the elements by striking them against another object.
Always inspect the element before and after cleaning. Use a light inside the element.
Park the forklift truck on a level surface, with the forks lowered, the parking brake applied, the transmission in NEUTRAL and the engine stopped.

1. Raise the hood.

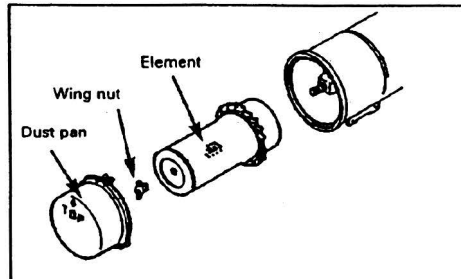

2. Remove the dust pan by releasing the latches at three places.

3. Unscrew the wing nut, and remove the element by pulling it.

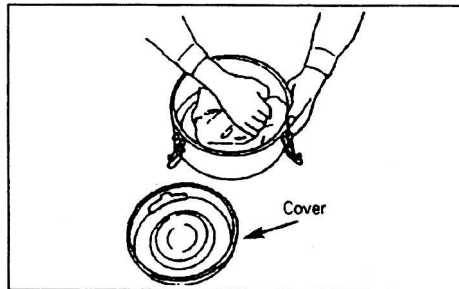

4. Remove the cover from the dust pan, and clean the inside of the pan by removing dust.

5. Clean the inside of the air cleaner housing.

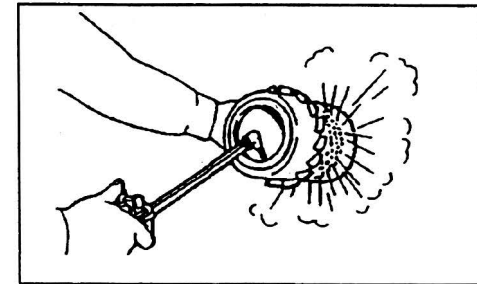

6. Direct air inside the element along the length of the pleats, and lightly tap it.

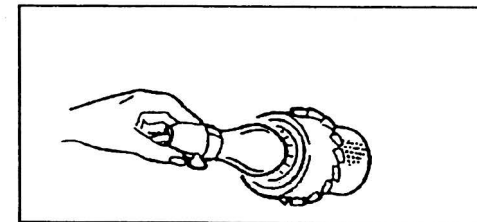

7. Insert a light inside a clean, dry element and check. Discard the element if tears or rips are found.

8. Put the element back in place.

9. Reinstall the dust cap.

10. Close the hood.

MAINTENANCE

- **Mast Supports
Lubricate**

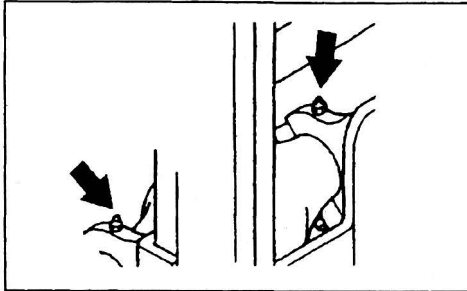

Lubricate 1 fitting on each support for a total of 2 fittings.

◆ **One Month After Delivery of a New Truck**

You must read and understand the warnings and instructions contained in this manual before performing any operation or maintenance procedure.

- **Hydraulic Tank Return Oil Filter
Change**

- Filter should be changed.

See **Hydraulic System, Change Return Oil Filter** in the Every 1200 Service Hours. and clean the oil tank, remove all the sediments.

- **Fuel Filter – Diesel Change**

- Filter should be changed.

See **Fuel Filter – Diesel, Change** in the Every 1200 Service Hours. and clean the oil tank, remove all the sediments.

MAINTENANCE

◆ Every 200 Service Hours or Monthly, Whichever Comes First

You must read and understand the warnings and instructions contained in this manual before performing any operation or maintenance procedure.

• **Wheel Nuts Retighten**

- Nuts should be retightened.

See **Wheel Nuts, Check-Tighten, when required.**

• **Check Oil Level**

Park the forklift truck on a level surface, parking brake applied, transmission in **NEUTRAL** and the engine stopped.

- 1 Raise the lift bracket high enough to gain access to the level/fill plug.
- 2 Use blocking under the inner mast to secure the lift bracket in this position

- 3 Remove the level/fill plug. Maintain lubricant level to the bottom of the plug brake operating.

- 4 Clean the level/fill plug and put it back in place.

- 5 Remove the blocking. Lower the lift bracket.

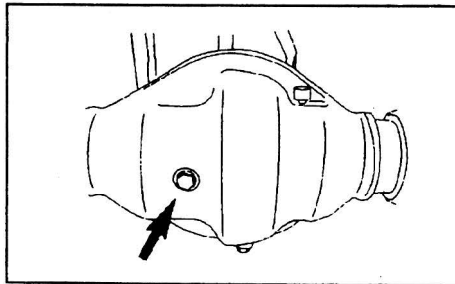

SERVICE DATA

Item		Truck model	20	25	30	35
		FD/FGL				
Refill capacities litre	Fule tank		52		60	
	Engine cooling system		8	9	9	12
	Torque convertor		4.2	5.2	5.5	
	Manual Differential		10		10.5	
	Powershift differential		10		12.5	
	Hydraulic		30		40	
	Brake fluid reservoir		0.2			
Battery electrolyte specific gravity corrected to 20°C :			1.28			

Main Specifications						
Item		Truck model	20	25	30	35
		FD/FGL				
Rated capacity,kg			2000	2500	3000	3500
Truck weight,unloaded,kg			3410	3770	4370	4750
Forklift Overall Dimensions L x W x T,mm			2515 x 1150 x 2070	2585 x 1150 x 2070	2698 x 1225 x 2090	2725 x 1225 x 2090
(Engine)		(Model)	XINCHAI 490BPG-1B,495BPG-34,498BPG-1,ISUZU240PKJ, YANMAR 4TNE-98L,WF491GP,NISSAN H25,MITSUBISHI-4G64, YANMAR 4TNV-92L			
		(Rated output/r.p.m) ,Kw	37kw/2650r/min,41kw/2650r/min,45kw/2550r/min,34.5kw/2500r/min, 44kw/2300r/min,43kw/2500r/min,41kw/2800r/min,37.5kw/2500r/min, 33kw/2450r/min			
(Tires)	(Frongt)	(Model)	7.00-12-12PR	7.00-12-12PR	28 x 9-15-14PR	28 x 9-15-14PR
		(Tire pressure) ,Mpa	0.70	0.70	0.70	0.70
	(Rear)	(Model)	6.00-9-10PR	6.00-9-10PR	6.50-10-10PR	6.50-10-10PR
		(Tire pressure) Mpa	0.65	0.65	0.65	0.65
(Fork size) ,L x W,mm			920 x 120	920 x 120	1070 x 135	1070 x 135

SERVICE DATA

Recommended fuels and oils

Fuel or oil	recommendation for ambient temperatures °C					
	-30	-20	-10	0	10	20 30
Fuel	-20#	-10#	0#			
Engine oil	Cd40					
Gear oil	85W/95V					
Hydraulic oil	YA-N32			YA-N46		
Brake fluid	SBF2115					
Grease	/3#LIBASE GREASENTE					
Fluid drive oil.	8#					

Antifreeze solution	Ambient temperature, °C	-37	-24	-18	-15	-12	0
	Concentration(%)	50	40	33	30	25	0

NOTICE:Avoid mixing lubricants. In some cases, different brands of lubricants are not compatible with each other and deteriorate when mixed. It is best to stick with the same brand at successive service intervals.

For refill capacities and measurements, see Specifications in this section.

Removable parts

Item	Truck model	20	25	30	35
	FD/FGL				
Frame	Exterior size,mm	2070x1150x1946	2070x1150x1946	2070x1225x1946	2070x1225x1946
	Weight,kg	480	480	530	530
Mast	Exterior size,mm	2045x1200x590	2045x1200x590	2090x1200x593	2130x1200x595
	Weight,kg	840	840	873	905
Counter weight	Exterior size,mm	674x1128x985	704x1128x985	777x1150x985	817x1150x985
	Weight,kg	1100	1450	1750	1900

Notice of Sideshift's installation, employment and security

Installation

1 Remove from pallet

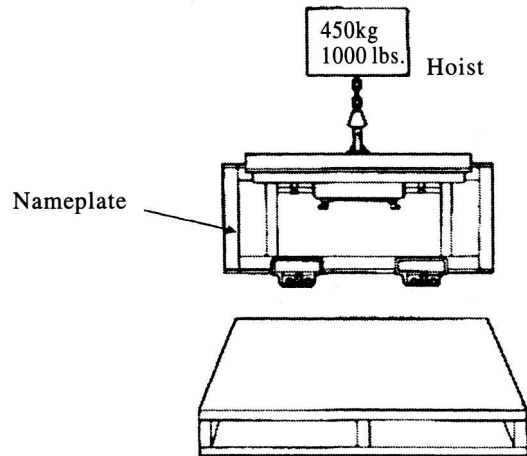

2 Remove Lower Hooks

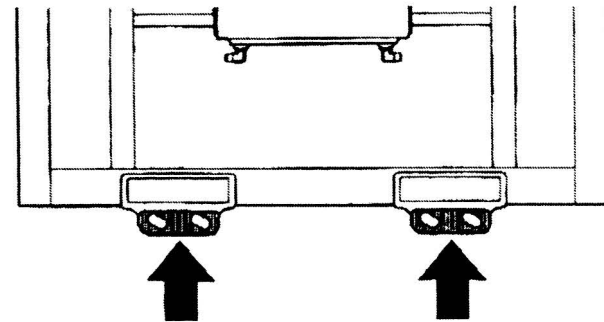

3 Mount on Lift truck

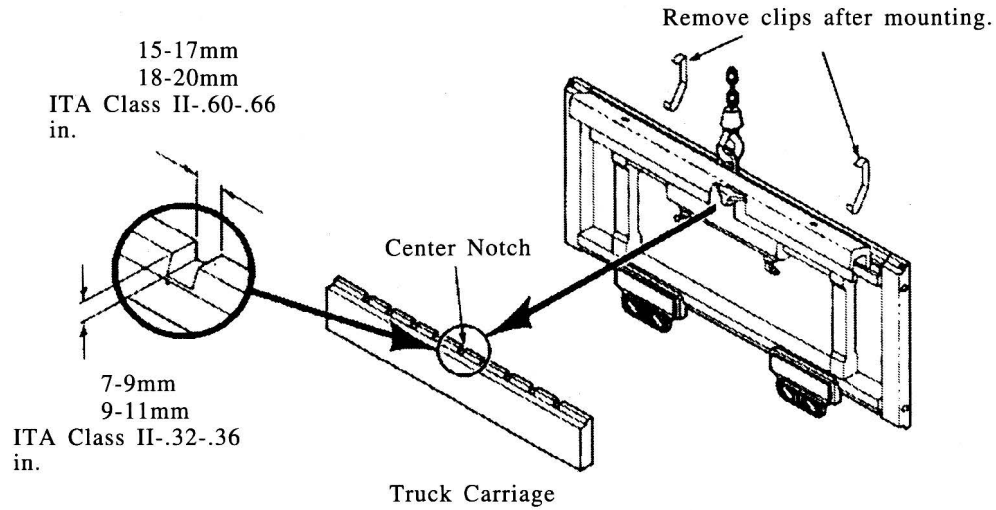

4 Install lower hooks

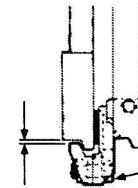
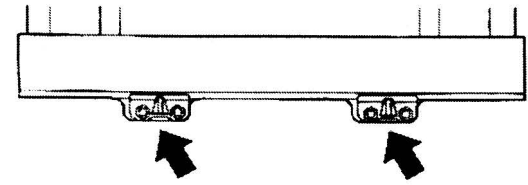

E-Series: 0.09 in
55D: 0.06 in
100D: 0.12 in
F-Series: 0.03-0.06 in

Torques
E-Series: 115-125 ft. lbs
55D: 115-125 ft. lbs
100D: 140-150 ft. lbs
F-Series: 120 ft. lbs

5 Flush supply hoses

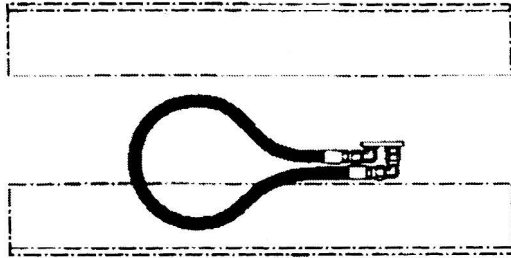

6 Install hoses

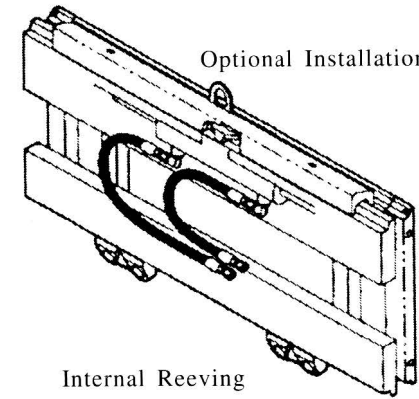

7 Install

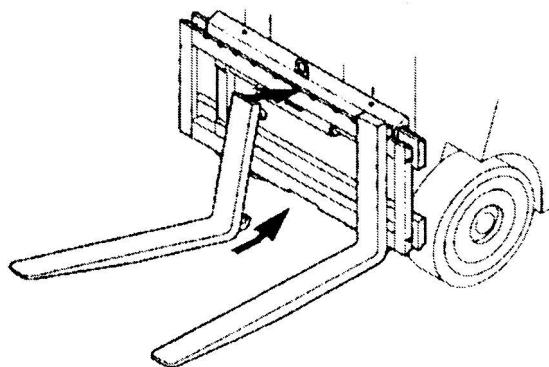

8 Install

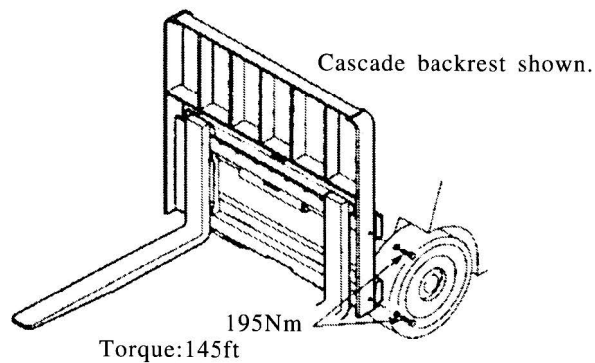

9 Lubrication Points

- The upper bearings and lower bearings should be greased at installation.
- After first 500 hours, lube all bearings with chassis grease.

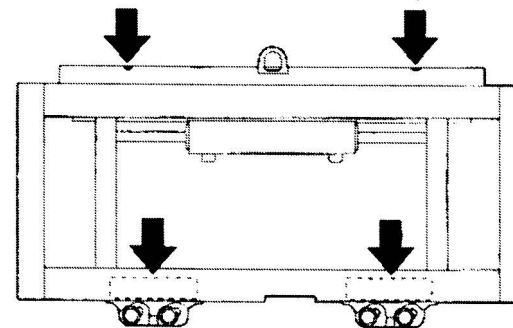

SIDESHIFTER OPERATION

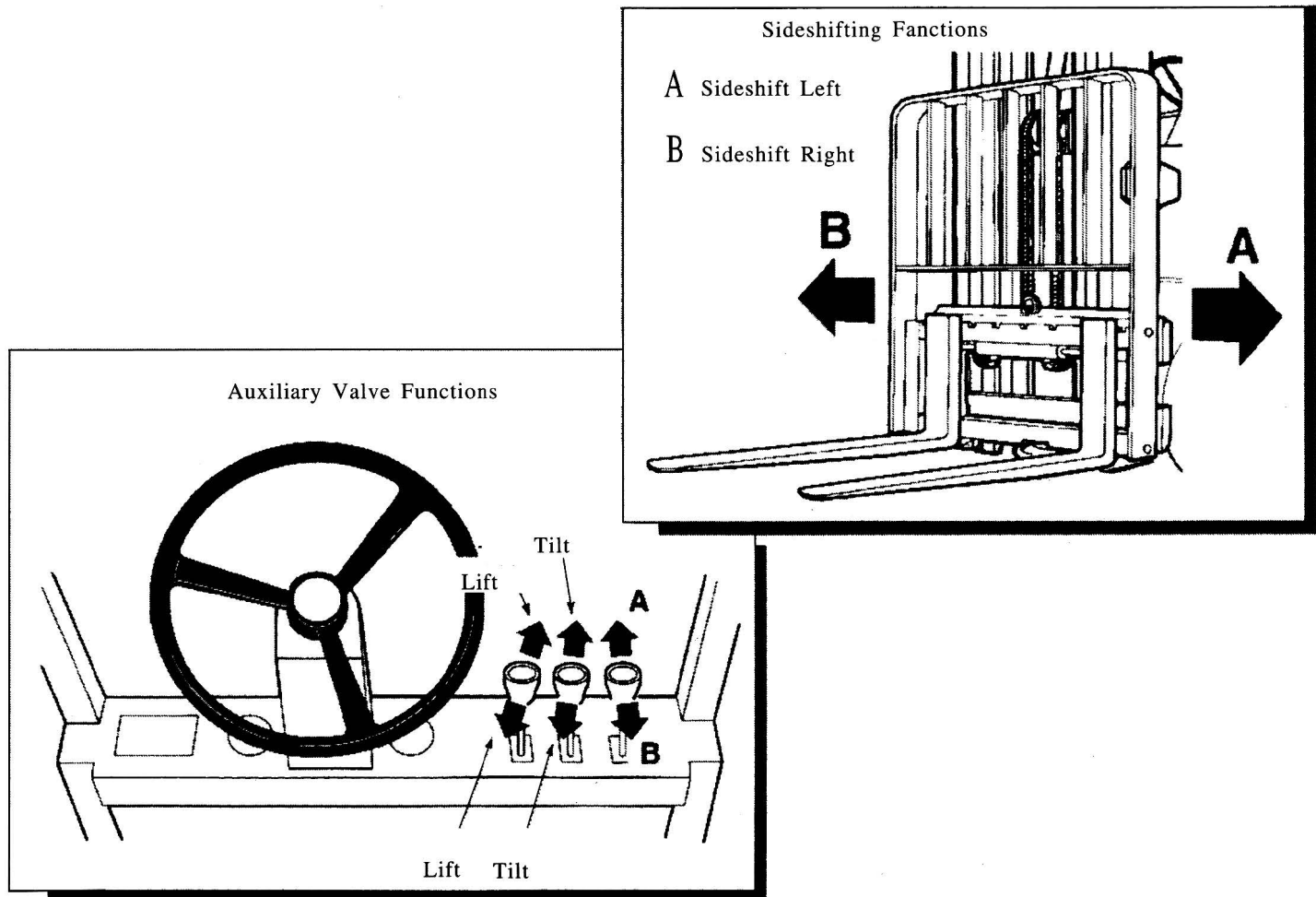

DAILY INSPECTION

- Check items shown each day. Inspect for problems and report to your supervisor in time. See Service Manual for maintenance and repair procedures.
- Lubricate the upper bearings and lower bearings every 500 hours of operation.

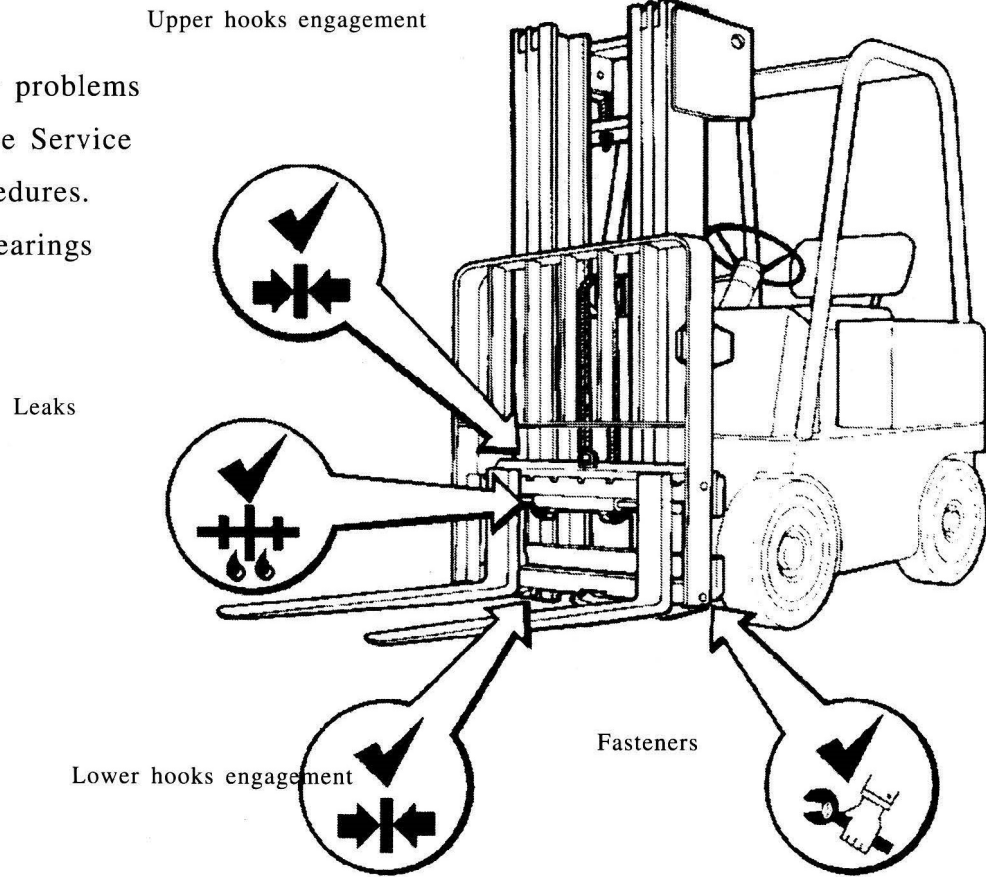

SAFETY RULES

Handling Loads

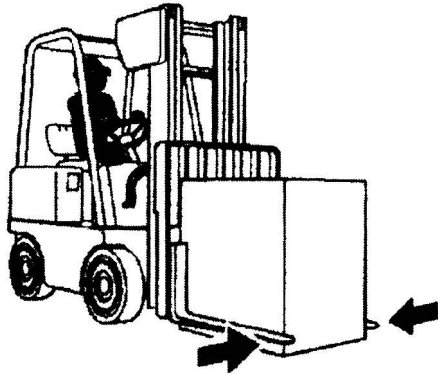

CAUTION: Do not put side load on forks

Limit sideshifting with raised load

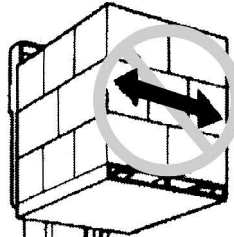

Top of load should not extend above backrest

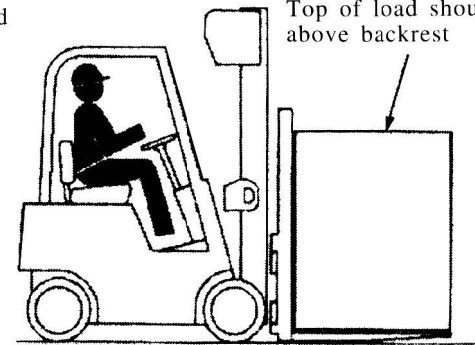

Center load prior to traveling

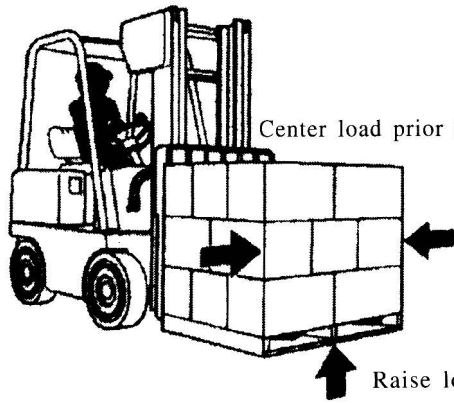

Raise load prior to sideshifting

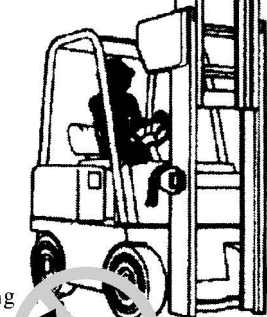

Limit truck movement with raised load

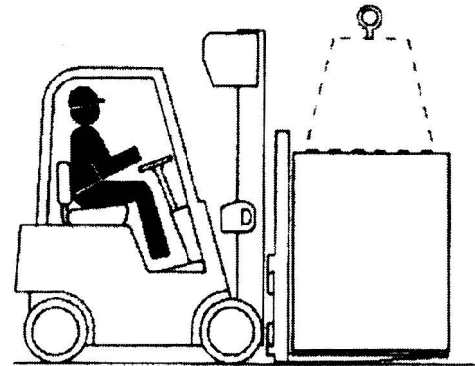

Load weight must not exceed combined truck/attachment capacity(see truck nameplate)

Total fork capacity(LH+RH fork) must be greater than load weight. Check capacity stamp on forks.

SAFETY RULES

Industrial lift Trucks

No riders



No reach through mast



No standing under load

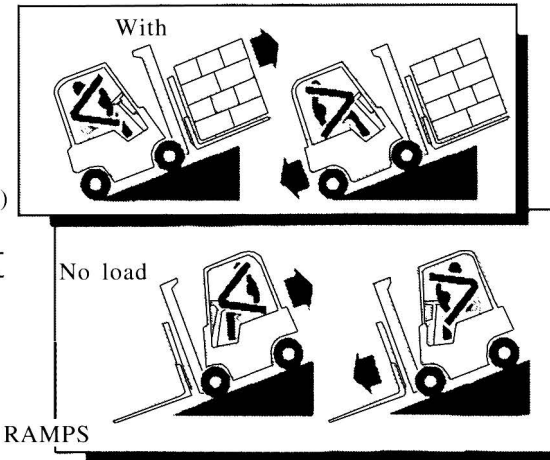
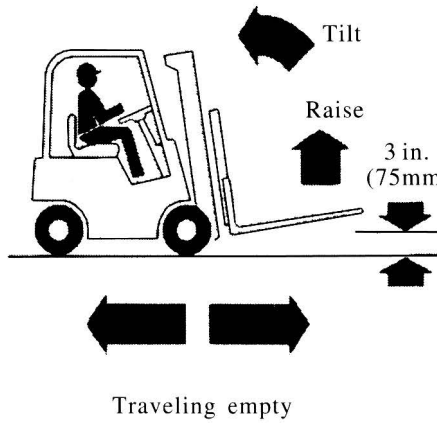
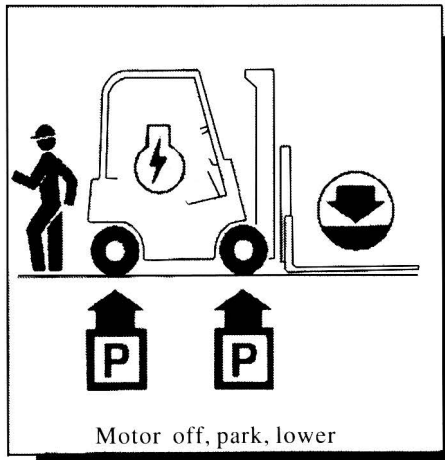

SAFETY RULES

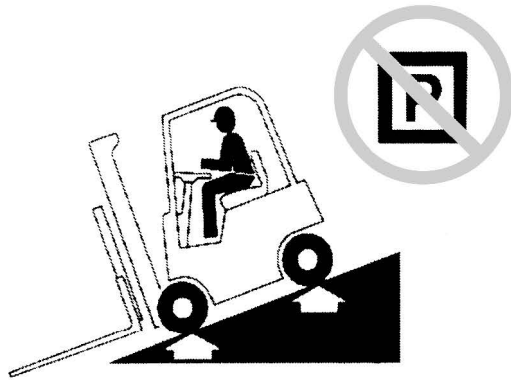



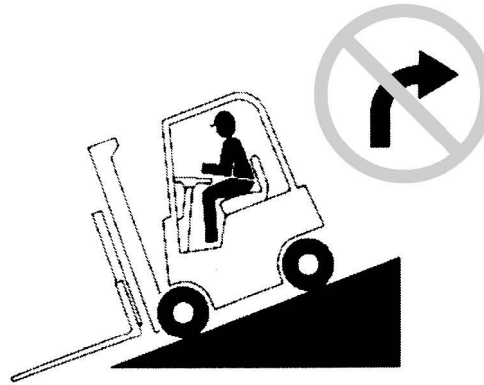



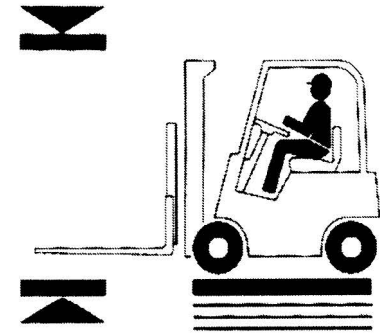

No parking on ramp

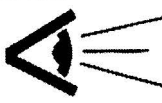

No parking on ramp

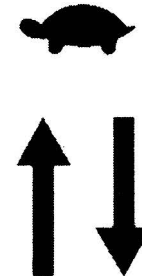
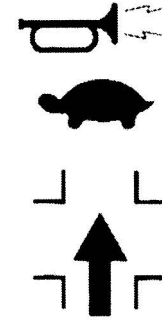

Watch clearances

<p>TRAFFIC</p>  <p>Observe</p>  <p>Wet</p>	 <p>Workers</p>  <p>Bumps</p>	 <p>Stops</p>  <p>Dips</p>	 <p>Slow for two way</p>	 <p>Sound horn, slow at intersection</p>	 <p>Sound horn, slow at corner</p>
--	---	--	--	--	--

LOAD TROUBLESHOOTING

LOAD WILL NOT SIDESHIFT

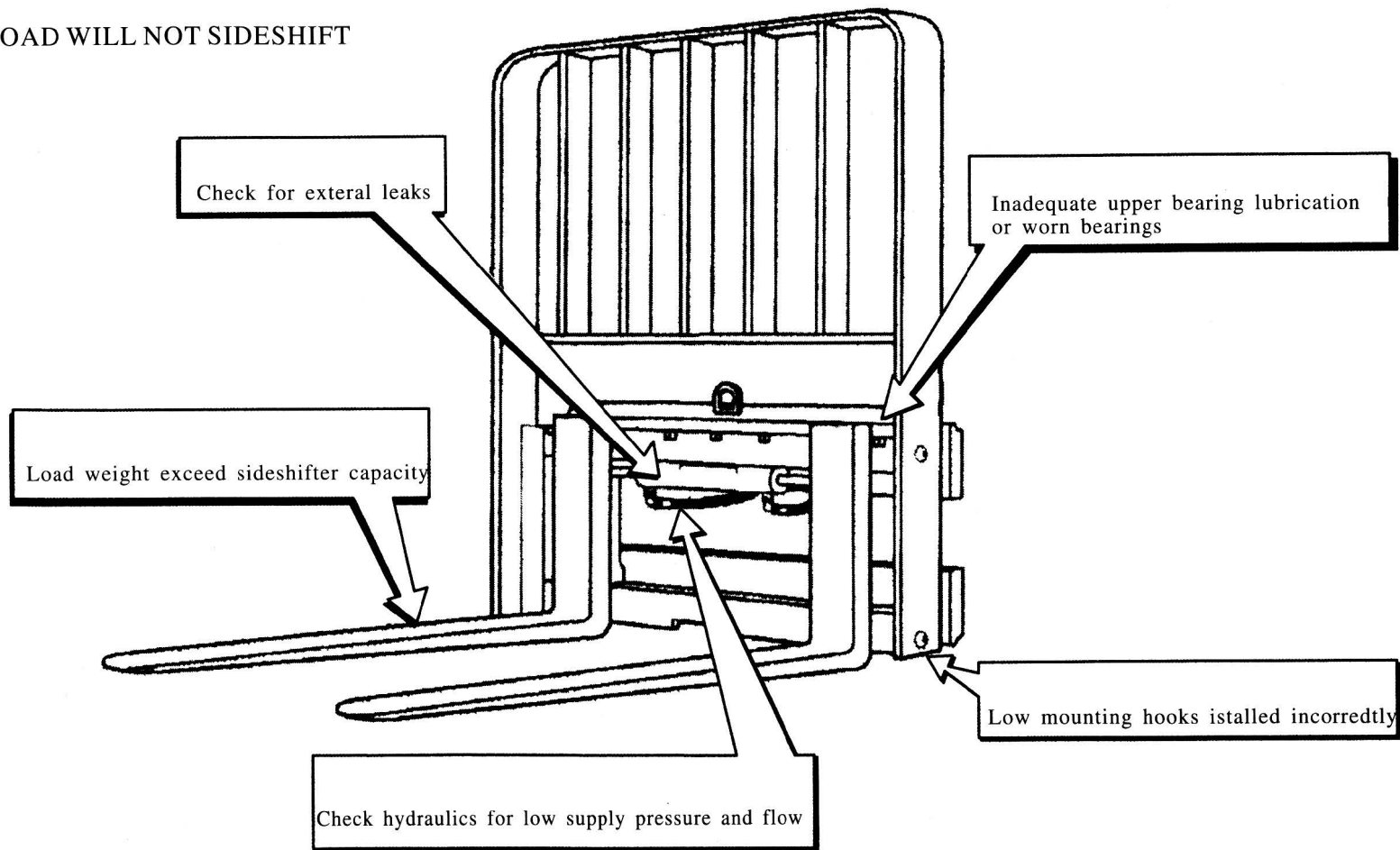

MAINTENACE RECORD

(Name)	(Date)	(Inspection parts)	(Lubrication parts)	(Replacement parts)	(Remark)