



INDUSTRIAL GROUP

**BTS**  
ENGINEERING

<https://prom-nasos.pro>

<https://bts.net.ua>

<https://prom-nasos.com.ua>

+38 095 656-37-57,

+38 067 360-71-01,

+38 063 362-12-31,

[info@prom-nasos.pro](mailto:info@prom-nasos.pro)

## USE AND MAINTENANCE MANUAL

# Simpool Light pH



# INDEX

1. INTRODUCTION.....	3
<b>1.1 WARNINGS.....</b>	<b>3</b>
<b>1.2 NORMATIVE REFERENCES .....</b>	<b>3</b>
<b>1.3 MODELS .....</b>	<b>4</b>
<b>1.4 INSTALLATION KIT .....</b>	<b>4</b>
2. ASSEMBLY .....	4
<b>2.1 WALL MOUNTING .....</b>	<b>4</b>
2.1.1 ASSEMBLY OF THE ACCESSORIES .....	4
3. FEATURES .....	6
<b>3.1 ELECTRICAL FEATURES .....</b>	<b>6</b>
<b>3.2 USER INTERFACE.....</b>	<b>6</b>
<b>3.3 WORKING MODE.....</b>	<b>6</b>
<b>3.4 OTHER FEATURES .....</b>	<b>7</b>
<b>3.5 CIRCUIT BOARD LAYOUT .....</b>	<b>7</b>
<b>3.6 CONNECTOR BOX .....</b>	<b>8</b>
4. HYDRAULIC CONNECTION .....	8
5. USER MENU .....	9
<b>5.1 DOSING MENU .....</b>	<b>9</b>
<b>5.2 ALARM MENU .....</b>	<b>9</b>
<b>5.3 PAUSE MENU .....</b>	<b>9</b>
<b>5.4 PRIMING MENU .....</b>	<b>9</b>
<b>5.5 OFF MENU .....</b>	<b>9</b>
<b>5.6 MENU INHIBIT .....</b>	<b>9</b>
6. FAST MENU.....	10
<b>6.1 FAST MENU – SETPOINT pH.....</b>	<b>10</b>
<b>6.2 FAST MENU - CALIBRATION.....</b>	<b>10</b>
7. PROGRAMMING.....	11
<b>7.1 PROGRAMMING MENU.....</b>	<b>11</b>
7.1.1 PROGRAMMING MENU – INHIBIT.....	11
7.1.2 PROGRAMMING MENU – RANGE ALARM .....	12
<b>7.2 DEFAULT PARAMETERS .....</b>	<b>12</b>
8. MAINTENANCE .....	13
<b>8.1 GENERAL RULES .....</b>	<b>13</b>
<b>8.2 PERIODIC MAINTENANCE .....</b>	<b>13</b>
<b>8.3 PLACING BACK PERISTALTIC TUBE.....</b>	<b>14</b>
APPENDIX A – OVERALL DIMENSION .....	15

## 1. INTRODUCTION

The range of Simpool Light programmable digital peristaltic pumps are designed to manage swimming pools and consists of the following models:

- *pH model: for dosage proportional to the pH value*
- *Rx model: for dosage proportional to the Redox value*

### 1.1 WARNINGS



***Before starting assembly, carefully read these instructions and follow them during installation.***



***If the instructions in this manual are not followed or carried out correctly, this may result in personal injury or damage the device and/or systems.***

***We recommend reading the label on the pump and checking the directions below:***

- ✓ ***The pressure of the injection point must be lower or equal to the pump's rated value!***
- ✓ ***When you receive the product, check the integrity of the pump and all of its parts. Should there be any anomalies, promptly notify the seller before performing any operations.***
- ✓ ***Keep this manual safe for future reference.***
- ✓ ***Before installing the pump make sure that the details provided on the adhesive plate attached to the pump correspond to those of the electrical system.***
- ✓ ***Do not handle the equipment with wet hands or feet!***
- ✓ ***Do not leave the equipment exposed to the elements!***
- ✓ ***Make sure the peristaltic tube is compatible with the liquid to be dosed!***
- ✓ ***The equipment must be handled by qualified personnel!***
- ✓ ***If any irregularities are experienced during pump operation, cut off the power supply and contact one of our customer care centres for any repairs!***
- ✓ ***In order for the pump to operate correctly it is necessary to use original spare parts or accessories. The manufacturer is relieved of any responsibility in the case of any breakdowns due to tampering or use of non-conforming parts and accessories***
- ✓ ***The electrical system must comply with regulations in force in the country where the system is installed.***
- ✓ ***The operating ambient temperature must not exceed 40°C with a relative humidity of 90% at 90°C.***

### 1.2 NORMATIVE REFERENCES

Our pumps are manufactured according to General Standards in force and in compliance with the following European Directives:

- n° 2014/30/CE " E.M.C.
- n° 2014/35/CE "DBT Low Voltage Directive"
- n° 2011/65/UE , 2012/19/UE "direttive RoHs e WEEE"

### 1.3 MODELS

Code	Power Supply	Motor Type	Flow Rate (l/h)	Pressure (bar)	Peristaltic Tube
ADS11V401000A000	230 VAC	230 VAC	1,4	1	Santoprene
ADS100301000A000	230 VAC	230 VAC	3	1	Santoprene

### 1.4 INSTALLATION KIT

When you purchase the pump, it includes everything required for correct installation, specifically:

- Bracket (code ADSP8000025)
- Plugs and screws (cod. ADSP6000041)
- pH 4.01 buffer solution (cod. ADSPH4)
- pH 7.00 buffer solution (code ADSPH7)
- Empty bottle to wash the pH probe (code ADSP4000020)
- PT100 temperature probe with 3 wires (optional, code ADSTS100N)
- Level Probe (optional, code ADSLG4)
- Foot strainer (\*)
- 2-in-1 injection probe-holder (code ADSP6000880)
- PVC suction and delivery tubes (\*)
- pH electrode with 5 m cable (code ADELTPH05)
- O-rings and spacers, ring nut for the pH electrode (\*);
- Drill bit Ø 24 (\*);

(\*) Kit components included in the ADSP6000631 code

## 2. ASSEMBLY



**We always recommend wearing protective masks, gloves, goggles and any other PPE during all installation steps and when handling chemical products.**

### 2.1 WALL MOUNTING

Proceed as follows to secure the pump to the wall:

- Fix the bracket to the wall using the plugs and screws supplied.
- Place the pump on the bracket.
- Ensure the fixing is stable.



**It is also recommended to install the pump in a dry environment, away from heat sources and exhaust vapour.**

#### 2.1.1 ASSEMBLY OF THE ACCESSORIES

- The probe-holder is installed on a D50 or D63 diameter tube on which a 24 mm diameter hole has been carried out;
- Check the direction of the flow in the tube to insert the injection tube correctly;
- The probe-holder must be positioned vertically +- 45°

##### 2.1.1.1 Performing a D24 mm hole

- Drill a 5 mm pre-hole at the centre of the upper part of the tube;
- Expand the hole with the 24mm drill bit supplied in the installation kit, until you introduce the whole drill bit in the tube;
- Deburr the hole by removing the PVC residues;

### 2.1.1.2 Installing probe holder

- Insert the O-ring on the small injection tube;
- Insert the small injection tube on the tube by following the direction of the flow, as indicated by the arrow on the label;
- Position the O-ring in place and hold it there. Apply the upper part of the probe-holder on the pool tube;
- Insert the two bolts (if it is a DN63 tube use the two spacers between the upper probe-holder and the lower collar). Apply the lower part of the probe-holder on the tube and tighten the nuts on the bolts;



**Screw the clamping bolts evenly to achieve proper fastening. Do not tighten a bolt fully home when the other one is still unscrewed.**



### 2.1.1.3 Installing a long electrode (120mm)

It is possible to use a standard electrode (12x120 mm). In this case it is necessary to use all the parts supplied;

Insert the following in sequence on the body of the probe: the ring nut and then alternate a spacer and an O-ring as shown in Fig. 4

Gently insert the electrode on the probe-holder by carrying out small clockwise and anticlockwise rotations to make the O-rings move down.

When all the components are in place, tighten the ring nut by hand.



**Never bend the electrode, which would otherwise be irreparably damaged. The internal part of the electrode is very fragile!**

### 3. FEATURES

#### 3.1 ELECTRICAL FEATURES

Power supply: 230VAC 50/60Hz

Fuse: 1 A RIT – model 5x20

#### 3.2 USER INTERFACE

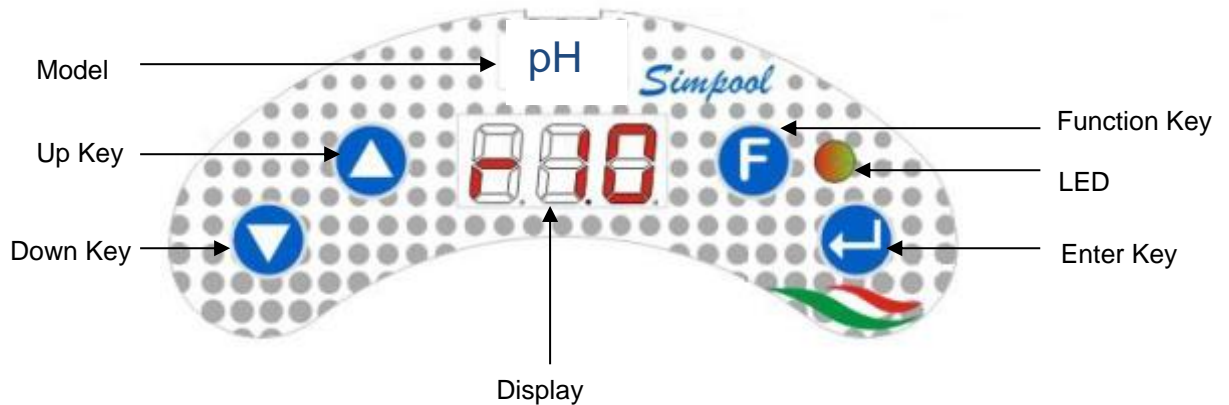

The keys on the panel are as follows:

- **Up/Down:** keys allow you to change the numerical values and scroll through the lists of options for all the available menu entries
- **F:** Function key allows access to probe calibration menu
- **Enter:** Enter key allows you to confirm the choices and access programming menu

#### 3.3 WORKING MODE

The pump has the following functional features:

- **Time-Pause Dosage.**  
The pump performs a time-pause dosage with cycle period of 5 minutes and 1,5 pH proportional band
- **Pause**  
The pump can be paused by pressing and holding the down arrow for a number of seconds. In this mode the LED is fixed on red.
- **End Pause**  
From pump pause mode, the pump switches back to a normal operation by pressing and holding the down arrow for a number of seconds
- **Probe Calibration**  
The probe calibration is performed across two points using buffer solutions (7.00 and 4.01 pH)
- **Dosage Mode**  
It is possible to set two dosing modes:
  - Acid
  - Alkaline
- **Setpoint**  
It is possible to set a setpoint
- **Inhibit**  
It is possible to set the inhibiting signal (On/Off)

- **Switch**  
The pump is equipped with a three position switch: ON/OFF/PRIMING (see 3.6)

**3.4 OTHER FEATURES**

- **Level Alarm** (if a low level switch or lance is connected)
- **Range Alarm**  
There are two Range alarm settings one for low and one for high these can be independently set. (see 7.1.2).

**3.5 CIRCUIT BOARD LAYOUT**

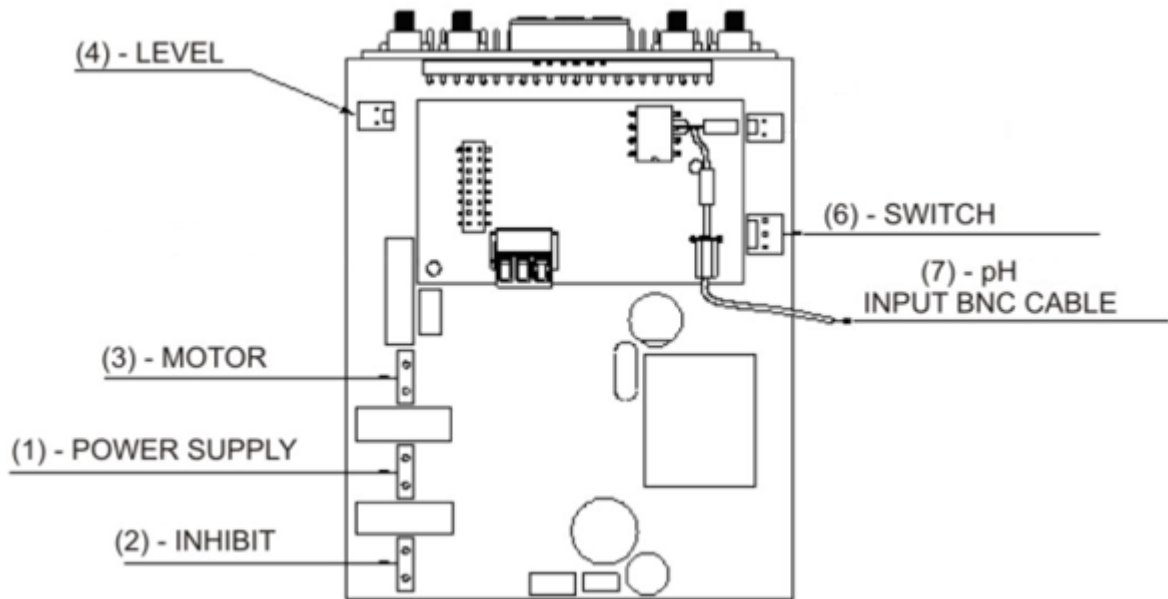



Rif.	Description
1	Equipment Power Supply Connector
2	Inhibiting signal connector
3	Motor connector
4	Level Connector
6	Switch Connector
7	pH Input BNC cable

### 3.6 CONNECTOR BOX

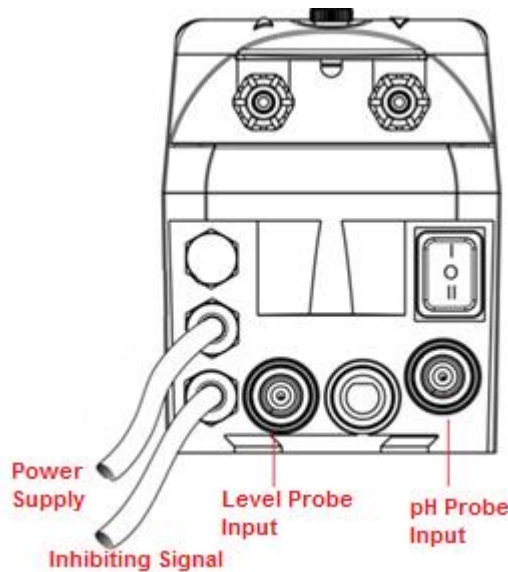
 **Before performing any maintenance on the pump, disconnect the power supply voltage of the machine!**



The switch has three positions:  
 : **The pump is active (ON)**  
 : **The pump is off (OFF)**  
 : **The pump is priming (MOM)**

The MOM position is monostable, therefore after setting the switch to MOM, when it is released the switch automatically goes back to OFF. The pump doses for 60 seconds at the maximum speed; if the MOM key is pressed again before the 60 seconds elapses, the priming of the pump stops.

### 4. HYDRAULIC CONNECTION

- Make sure the suction tube is placed in the chemical container and then connected to the pump's intake fitting (marked with the ▲ symbol on the cover) and tightened with the correct tube nut.
- Make sure the delivery tube is inserted in the pump's delivery fitting (marked with the ▼ symbol on the cover) and tightened with the correct tube nut. It must then be connected to the infeed fitting of the injection probe-holder.

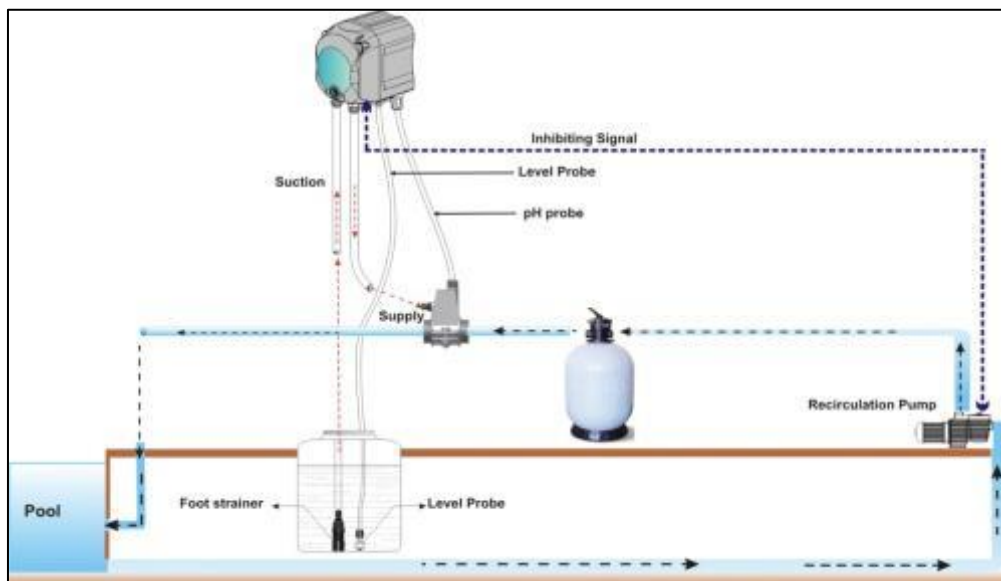



## 5. USER MENU

### 5.1 DOSING MENU

The menu displays is the following:

7.2

The display shows the pH reading value.

When the pump is in dosing mode (**TIME**), the pH value on the display and the green LED blink.

When the pump is not dosing (**PAUSE**), the pH value on the display is fixed, and the green LED blinks



### 5.2 ALARM MENU

ALR  
RNG/LIV

SIMPOOL light pump has a “range” and “level” alarm.

If an alarm is active, the pump will display **ALR** and the name of alarm in regular sequence. The red LED blinks. **ALR** is out of range alarm, **LIV** is level alarm

### 5.3 PAUSE MENU

The pump can be paused, by pressing & holding the  for 3 seconds. Display shows PSE. Press and hold the  for 3 seconds to return to dosing mode.

PSE

The LED is fixed red

### 5.4 PRIMING MENU

The priming of the pump can be performed by switching **MOM** . The menu displays:

PRI

Green LED blinks

The priming function has a running time of 60 seconds. You must press the button again to stop priming before the 60 seconds and return to OFF state.

### 5.5 OFF MENU

OFF state of the pump is performed with the switch in **O OFF** position. The pump is on but doesn't perform any kind of operation. The menu displays:

OFF

### 5.6 MENU INHIBIT

When the pump receives an inhibitor signal and the signal is cut the display shows:

no.S.

Red LED blink

## 6. FAST MENU

### 6.1 FAST MENU – SETPOINT pH

The set point menu allows you to set a pH set point.

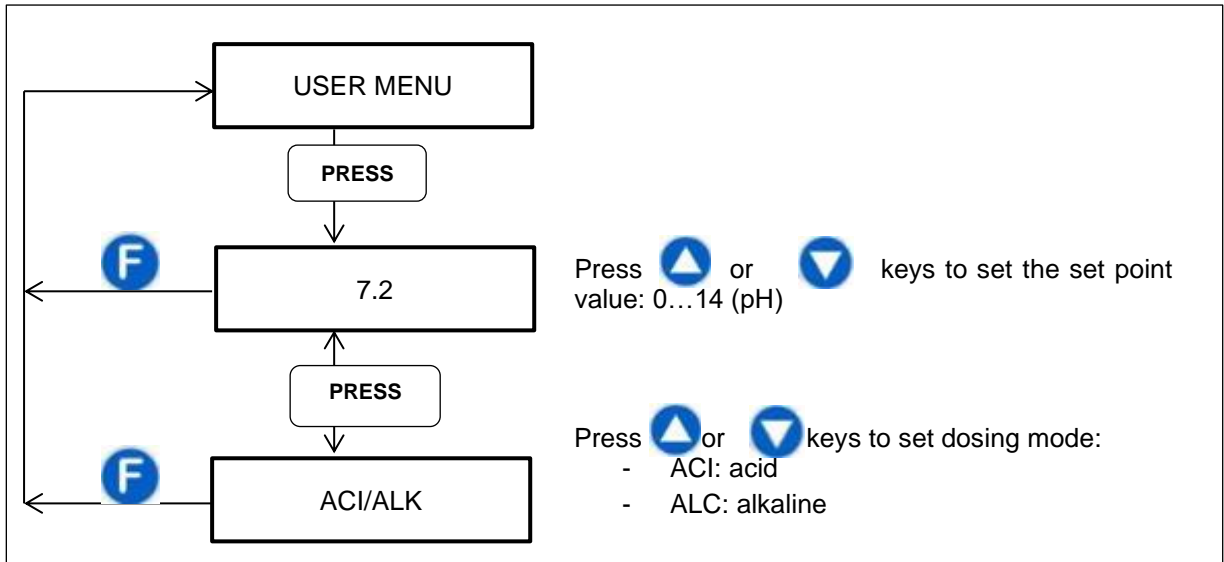

To exist this menu at any time press Key.

### 6.2 FAST MENU - CALIBRATION

The fast menu calibration allows calibration of the pH probe.

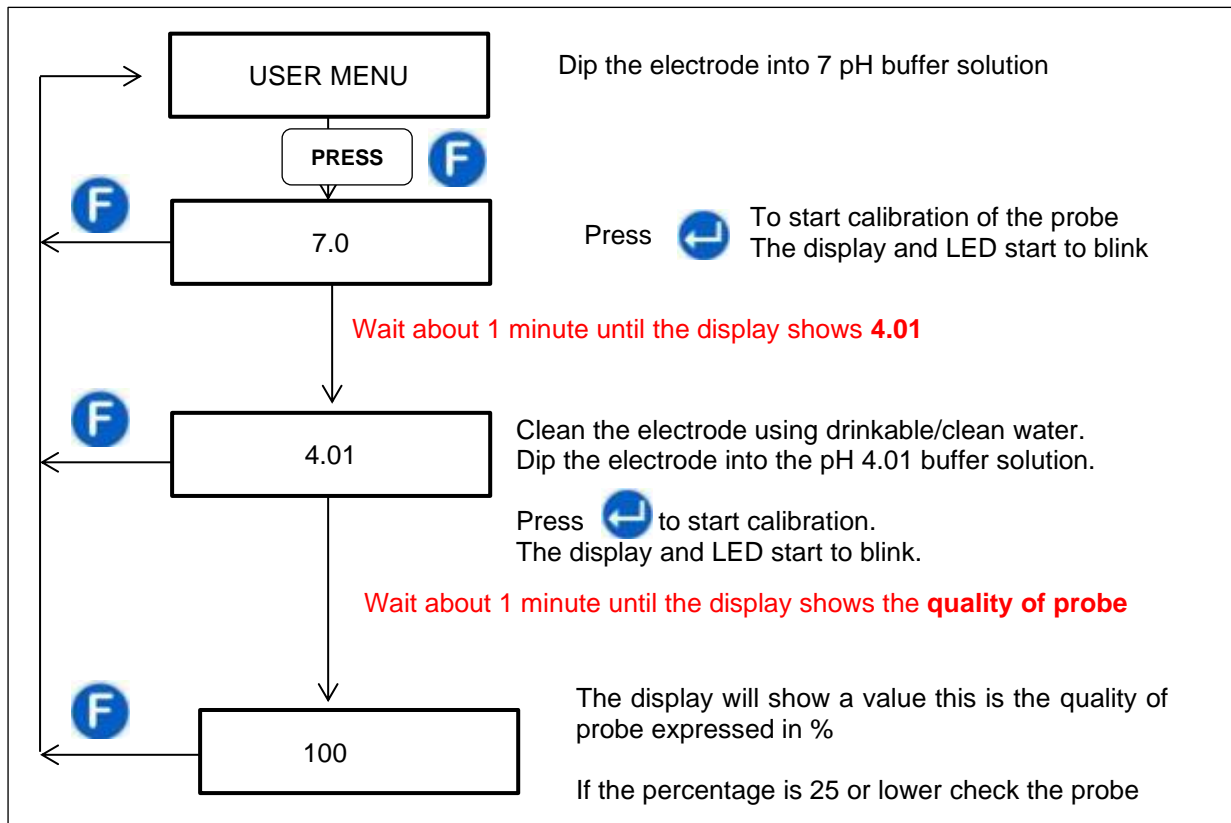

To exist this menu press Key

## 7. PROGRAMMING

In addition to the Fast Menu there is also a programming menu.

You can enter into the programming menu by pressing and holding for 3 seconds the  key.

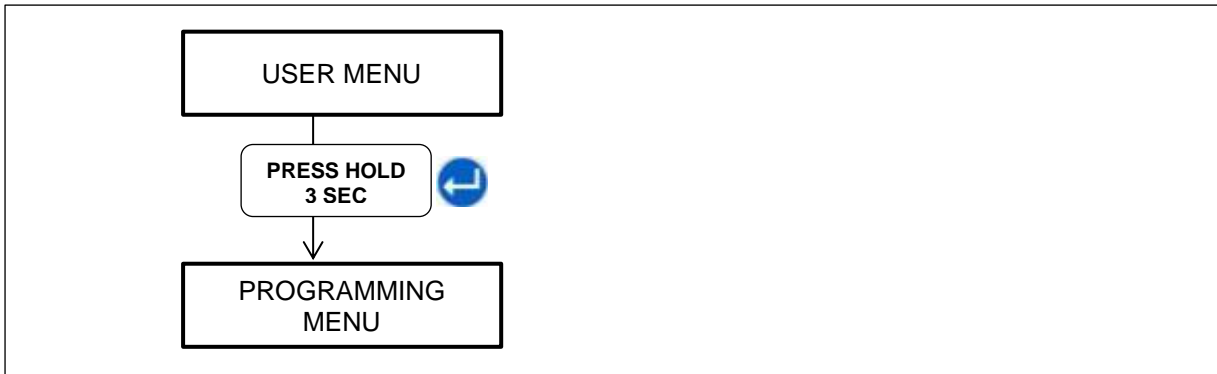

### 7.1 PROGRAMMING MENU

The Display will show the following:

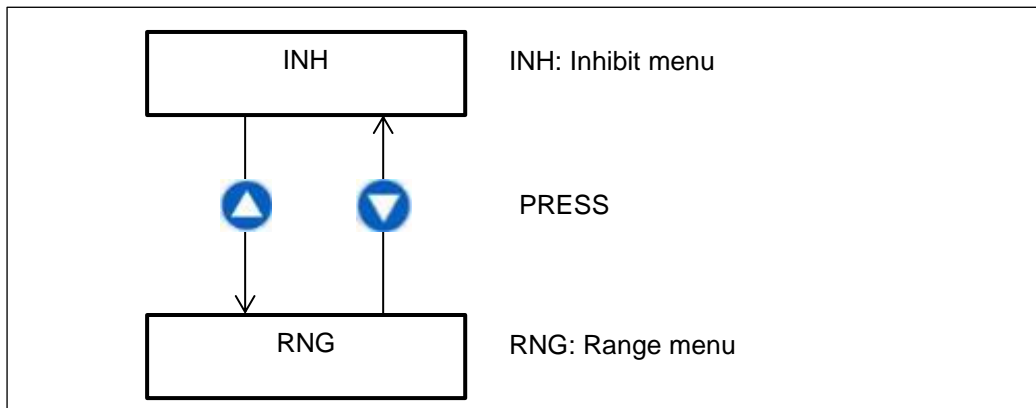

Press  key to return to the USER MENU.

#### 7.1.1 PROGRAMMING MENU – INHIBIT

You can set Inhibit signal.

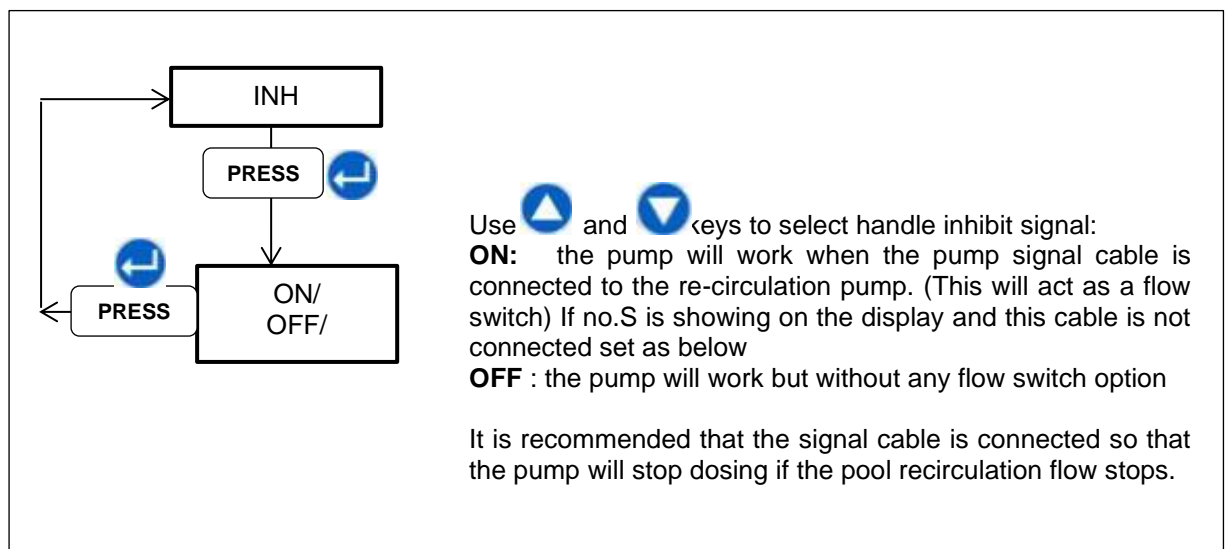

7.1.2 PROGRAMMING MENU – RANGE ALARM

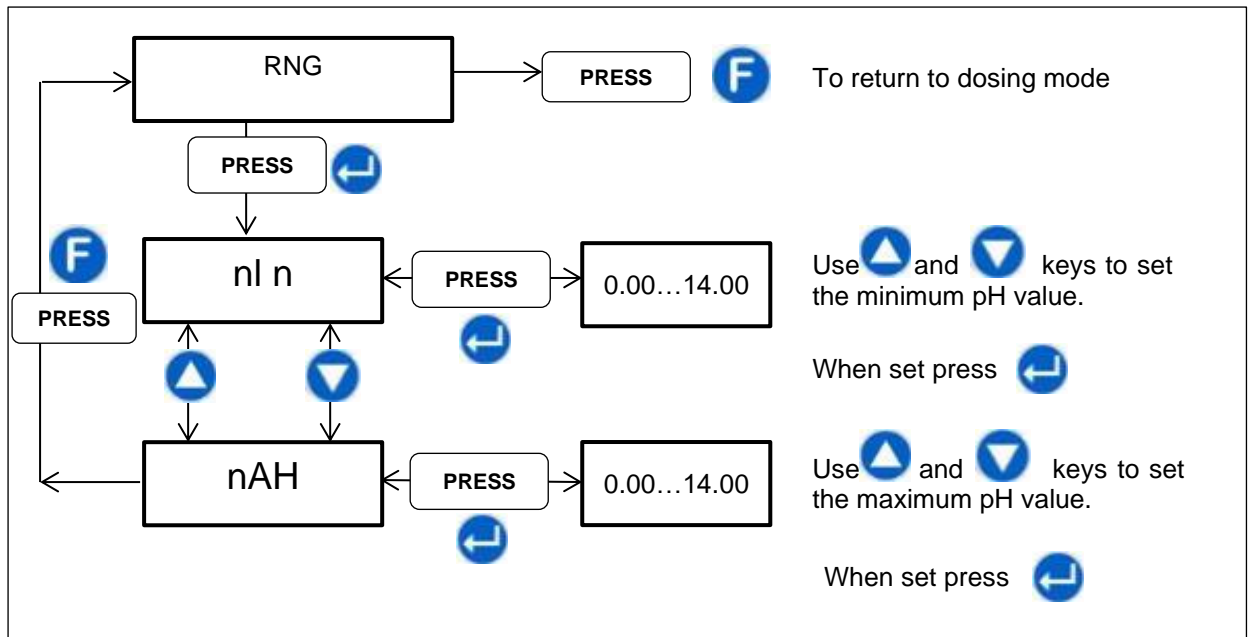

7.2 DEFAULT PARAMETERS

pH Setpoint	7.00
Dosage Mode	Acid
Inhibit	ON
Min pH	6.00
Max pH	8.00

## 8. MAINTENANCE

This section advises the general rules you need to follow to operate the pump correctly and the steps to carry out periodically to ensure optimal conditions are maintained over time.

### 8.1 GENERAL RULES

Maintenance operations must be conducted systematically and accurately by following the recommendations reported below. It is difficult to define the standard times required for maintenance beforehand, as there are a number of factors that determine the wear of the pump and in particular the parts that are in contact with the liquid. This also applies to the type of product used to clean the materials that are in contact with it (valves, tubes etc.) as it depends on the compatibility of the material with the chemical product being dosed.

Having said this, we can take as an example a product, such as sodium hypochlorite, that develops crystals, which is often used with our pumps, and with which we have a great deal of experience, and trace an identity kit of the type of maintenance required.

### 8.2 PERIODIC MAINTENANCE

- Check the foot strainer and clean/replace it periodically from any residuals of crystallised product or dirt deposits.
- Ensure there are no impurities in the suction and delivery tubes, because they may damage the peristaltic tube and, at the same time, cause anomalies in the flow rate;
- **Pump materials in contact with the chemical product such as: foot strainer and injection valve must be checked and cleaned at least every three months.** If the products are particularly aggressive increase the frequency of cleaning;
- Calibrate the pump periodically;

#### *Removing the peristaltic tube*

Remove the suction and delivery tubing

**Step 1** - Open the front glass cover



**Step 2**- Turn the roller clockwise and release the (left) intake ring nut

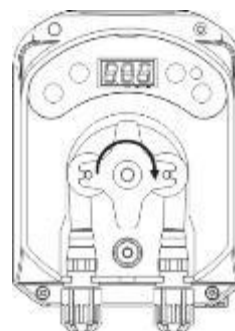

**Step 3** - Removing the tube

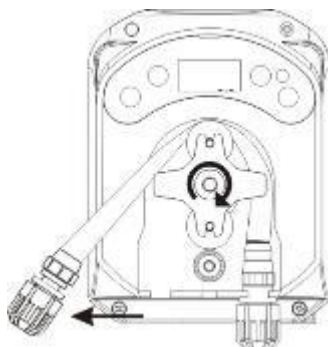

**Step 4** - Release t the (right) delivery ring nut and remove it completely



### 8.3 PLACING BACK PERISTALTIC TUBE

**Step 1** - Position the tube and secure it on the left-hand side



**Step 2** - Insert it in the bell by turning the roller

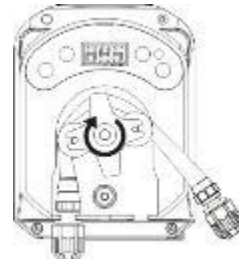

**Step 3** - Close the front glass

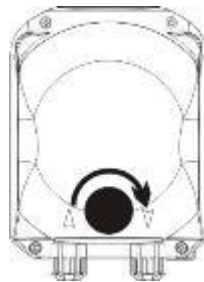

Reconnect the suction and delivery tubing.

**APPENDIX A – OVERALL DIMENSION**

